

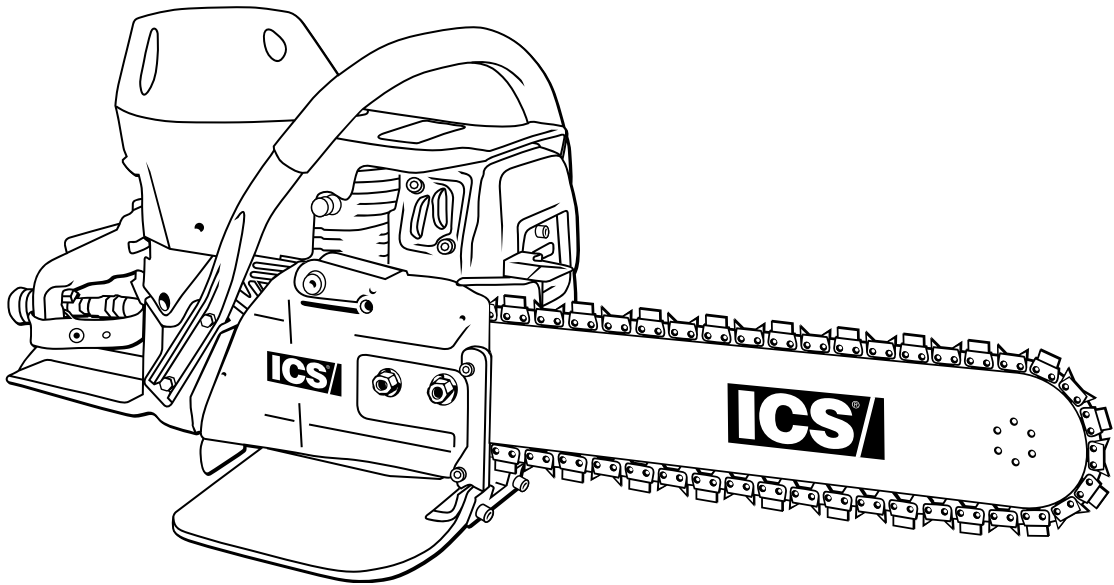

613GC



SERVICE MANUAL

SECTION	SECTION TITLE	PAGE NUMBER
	SHOP MANUAL USE	2
1	TOOLS	3
2	SAW SPECIFICATIONS	4
3	SERIAL NUMBER LOCATION	5
4	SPARE PARTS DIAGRAM (TORQUE AND LOCTITE®)	6
5	AIR INTAKE	15
6	SPARK PLUG	17
7	CLUTCH & RIM SPROCKET	19
8	STARTER SYSTEM	23
9	WALLWALKER	29
10	CYLINDER COVER	31
11	MUFFLER	34
12	CARBURETOR	36
13	CYLINDER & PISTON	38
14	WATER HOSE	47
15	IGNITION COIL	49
16	FLYWHEEL	51
17	BOTTOM GUARD	53
18	FRONT HANDLE	54
19	FUEL TANK	55
20	CRANKCASE	57
21	BAR STUDS	65
22	TENSIONER	66
23	CARBURETOR TUNING	67
24	IDLE SPEED ADJUSTMENT	71
25	TROUBLESHOOTING DIAGRAMS	72
26	TROUBLESHOOTING: FUEL SYSTEM LEAKS	74
27	TROUBLESHOOTING: CRANKCASE LEAKS	77
	APPENDIX	
	1. SPARK PLUG REFERENCE GUIDE	78

Shop Manual Use

This manual contains all the technical information necessary for carrying out repairs on the 613GC cut-off saw. For safe, efficient work, it is of prime importance that the values indicated be adhered to. Routine periodic maintenance is covered in the operator's manual included with each cut-off saw.

General Shop Rules

- Always use the right tools for the job, otherwise components may be damaged.
- Use a plastic dead blow mallet to separate parts attached solidly to each other.
- Mark mating parts as a reassembly reference.
- Keep component parts together as a group. Assemble screws and nuts into appropriate subgroups.
- When reassembling, clean all parts carefully, lubricate moving parts and replace all oil seals, orings, gaskets, washers and self-locking nuts.
- **For best results, use only original ICS® replacement parts.**

General Recommendations

- Some procedures in this manual require the use of special tools. A complete tool kit for ICS® cut-off saws is available from ICS®.
- Detailed carburetor maintenance and overhaul information is available in Walbro's Diaphragm Carburetor Service Manual. Walbro can be contacted at <http://www.walbro.com> or by calling 1.989.872.2131.

Gas Saw Service Tool Kit - P/N 71700

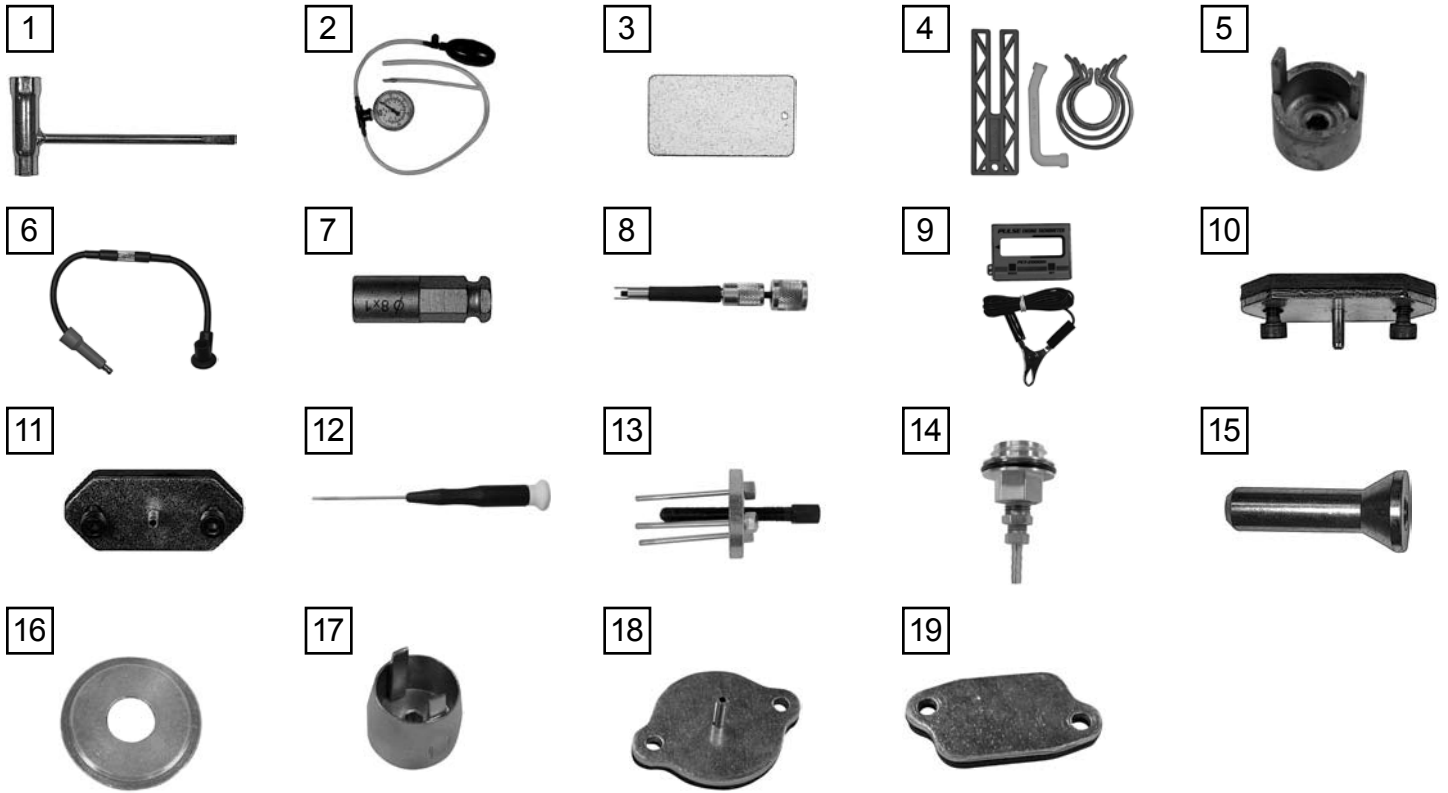

P/N	DESCRIPTION
1	71521 SCRENCH
2	71541 PRESSURE GAUGE BULB
3	71542 COIL/FLYWHEEL TIMING SHIM
4	71543 CYLINDER ASSEMBLY CLAMPS & PISTON STOP
5	71546 613 SHOCK ABSORBER TOOL
6	71547 SPARK TESTER
7	71548 613 FLYWHEEL DISASSEMBLY TOOL
8	71550 LIMITER CAP REMOVAL TOOL
9	71565 ELECTRONIC TACHOMETER
10	71569 613GC INDUCTION SEAL FLANGE W/ SCREWS
11	71570 613GC EXHAUST SEAL FLANGE W/SCREWS
12	71573 TUNING SCREWDRIVER
13	73410 633GC FLYWHEEL PULLER
14	73425 633GC FUEL PRESSURE CAP
15	73428 613GC & 633GC MAIN BEARING DRIVER TOOL
16	73429 633 MAIN BEARING SPACING TOOL
17	73430 633GC SHOCK ABSORBER TOOL
18	73431 633GC INTAKE PORT COVER TOOL
19	73432 633GC EXHAUST PORT COVER TOOL

SPECIFICATIONS

Engine Type	2-Stroke Single Cylinder Air Cooled
Displacement	4.9 cu. in. (80.7 cc)
Horsepower	5.7 hp (4.2 kW) @ 9000 rpm
Engine Speed	12,000 ± 500 rpm, electronically governed 2800-3200 rpm @ idle
Chain Speed	5300 fpm (27 m/s), free running 4000 fps (20 m/s), in the cut
Weight	21 lbs. (9.5 kg) with bar and chain
Cutting Depth	Up to 12 inches (30 cm)
Dimensions	18 inches (45 cm) length 11.5 inches (29 cm) height 10 inches (25 cm) width
Carburetor	Walbro diaphragm WJ-85B
Air Filtration	Dry nylon
Starter	Dust and water shielded
Ignition	Electronic speed governing, water sealed
Clutch	Three-weight, single spring, centrifugal
Fuel Mix Ratio	25:1 gasoline to oil with brand name gasoline and ICS® 2-stroke engine oil, or other high quality 2-stroke engine oil for air cooled engines.
Fuel Capacity	0.23 gal (0.88 liter) 15-18 minute run time
Water Supply	Minimum 20 psi (1.5 bar)
Noise Level	100 dB @ 1 meter
Vibration Level	10.5 m/s
Spark Plug TYPE	Champion RCJ-7Y (for spark plug reference guide see page 78)
Spark Plug Gap	0.02 inches (0.5 mm)
Sprocket Type	8-tooth rim sprocket

3 613GC Cut-Off serial number series.

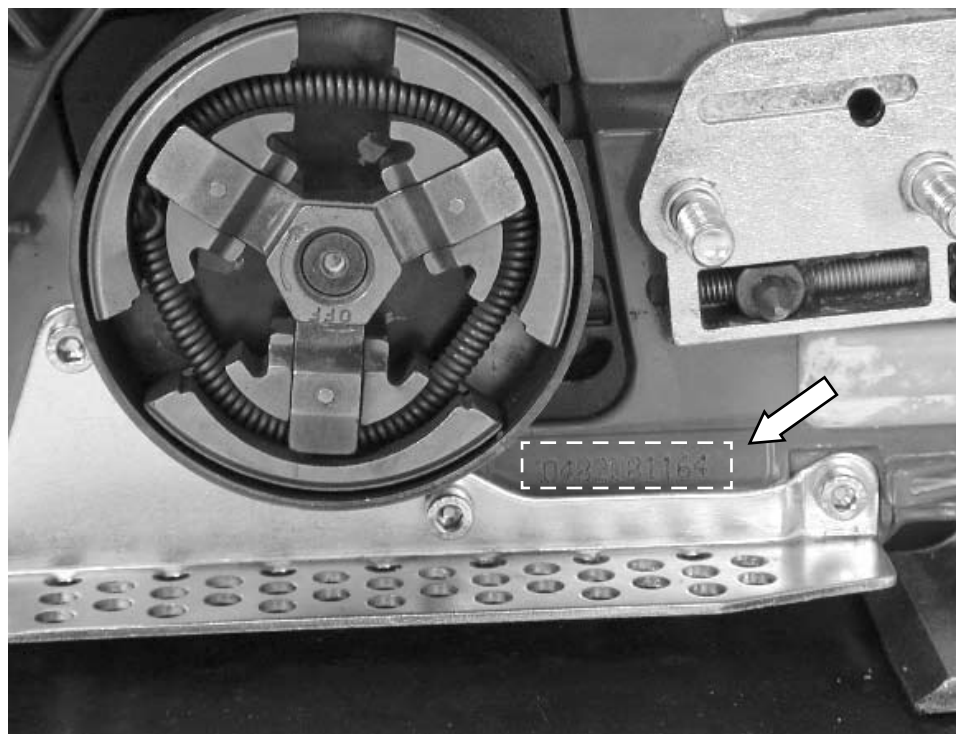

4 This section covers torque, Loctite, and lubrication requirements of the individual components. The key numbers used are not related to the key numbers in the 613GC Replacement Parts Price List.

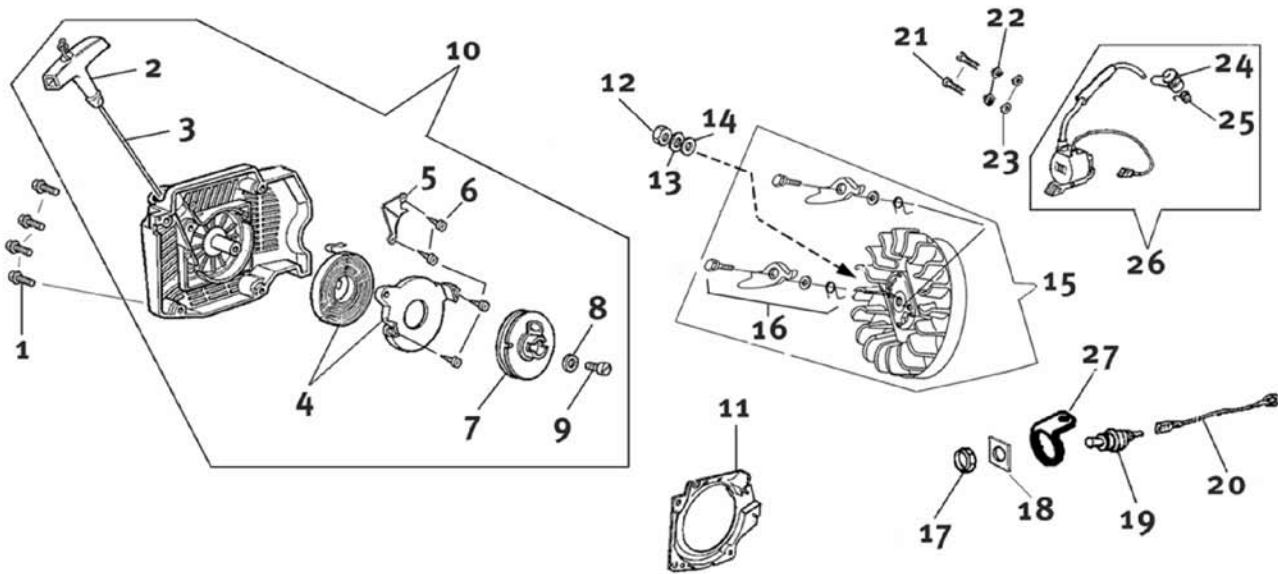

KEY	DESCRIPTION	TORQUE		LOCTITE® 242	PART NUMBER
		Nm	in-lbs.		
1	SCREW	0.4	35	X	73866
2	STARTER ROPE HANDLE				505514
3	STARTER ROPE				73904
4	STARTER COIL SPRING & HOUSING				73909
5	STARTER CASE PLATE				71451
6	STARTER COIL SPRING & HOUSING SCREW				73910
7	STARTER ROPE PULLEY				73913
8	STARTER PULLEY WASHER				73905
9	STARTER PULLEY SCREW	0.6	52	X	73907
10	STARTER COVER ASSEMBLY				71415
11	STARTER COVER AIR DEFLECTOR				73908
12	NUT	3.0	260		73891
13	WASHER				73911
14	WAVE WASHER				73912
15	FLYWHEEL ASSEMBLY	0.7	61		509163
16	STARTER PAWL ASSEMBLY				509207
18	SCREW	0.3	26	X	73914
19	SWITCH, IGNITION TOGGLE				73237
20	IGNITION TOGGLE CABLE				73919
21	SCREW				73914
22	WAVE WASHER				73285
23	PLAIN WASHER				73890
24	SPARK PLUG CAP				73241
25	SPARK PLUG SPRING				73917
26	IGNITION COIL WITH SPARK PLUG LEAD & PRIMARY				73920
27	SWITCH GROUND CONNECTION PLATE				71449

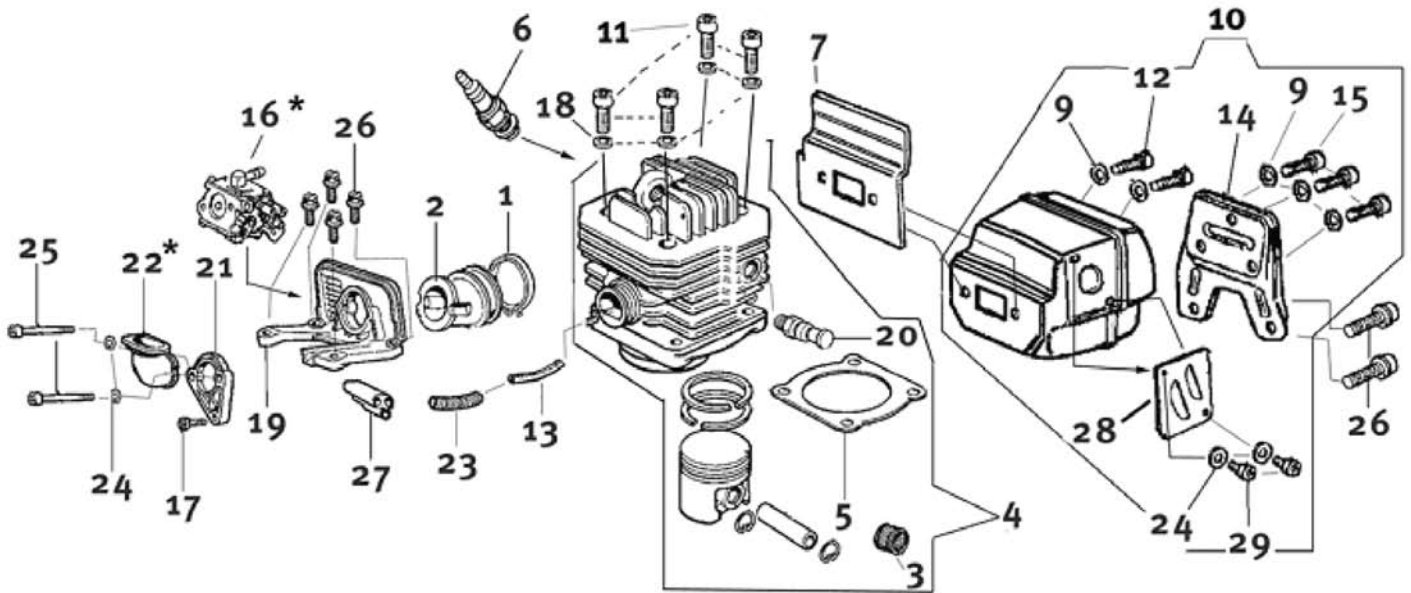

KEY	DESCRIPTION	TORQUE		LOCTITE® 242	PART NUMBER
		Nm	in-lbs.		
1	REAR MANIFOLD CLAMP				73867
2	REAR MANIFOLD				73868
3	WRIST PIN NEEDLE BEARING				73869
4	COMPLETE PISTON/CYLINDER ASSEMBLY				71413
5	CYLINDER BASE GASKET ASSEMBLY				71412
6	SPARK PLUG	2.8	243		73199
7	CYLINDER TO MUFFLER GASKET				73881
9	CARBURETOR ATTACHMENT SCREW WASHER				73327
10	MUFFLER ASSEMBLY				71411
11	CYLINDER BLOCK BOLT	1.1	95	X	73874
12	MUFFLER MOUNTING SCREW	1.0	87		73883
13	CARBURETOR PULSE TUBE				73898
14	MUFFLER SUPPORT BRACKET				73884
15	MUFFLER SUPPORT BRACKET SCREW	0.9	78		73885
16	COMPLETE CARBURETOR WJ-85B				71762
17	INTAKE MANIFOLD FLANGE SCREW	0.4	35	X	73901
18	WASHER				73250
19	CARBURETOR SUPPORT BRACKET				73895
20	DECOMPRESSION VALVE	1.3	113		71642
21	INTAKE MANIFOLD FLANGE				73947
22	INTAKE MANIFOLD				71735
23	CARBURETOR PULSE TUBE PROTECTOR				73888
24	WASHER				73897
25	CARBURETOR ATTACHMENT SCREW	0.5	43		73902
26	SCREW	0.4	35	X	73866
27	SCREW GUIDE	0.6	52		73899
28	MUFFLER DEFLECTOR				71481
29	SCREW	0.4	35		71482

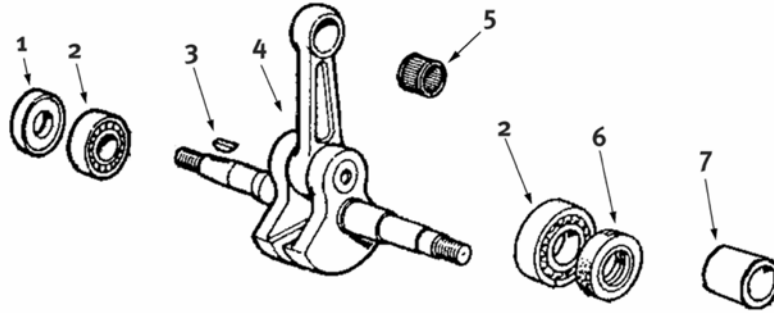

KEY	DESCRIPTION	TORQUE		LOCTITE® 242	PART NUMBER
		Nm	in-lbs.		
1	CRANKSHAFT SEAL FLYWHEEL SIDE				73877
2	CRANKSHAFT BEARING				73209
3	CRANKSHAFT FLYWHEEL WOODRUFF KEY				73878
4	CRANKSHAFT ASSEMBLY				71410
5	WRIST PIN NEEDLE BEARING				73869
6	CLUTCH SIDE MAIN BEARING SEAL-INSIDE				73289
7	CRANKSHAFT BUSHING				71452

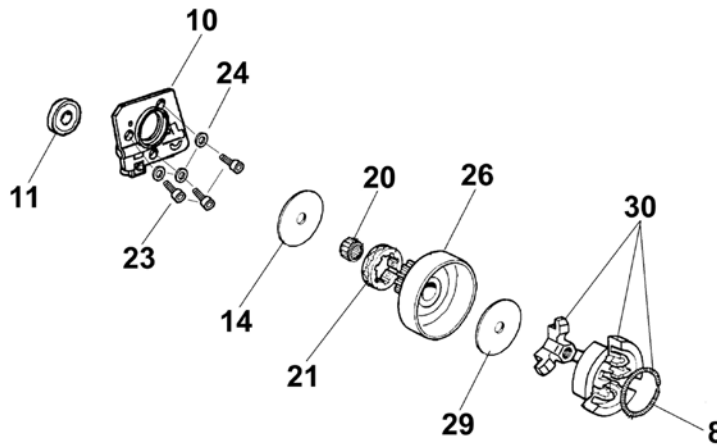

KEY	DESCRIPTION	TORQUE		LOCTITE® 242	PART NUMBER
		Nm	in-lbs.		
1	OUTER CRANKCASE SEAL CLUTCH SIDE				73931
2	OUTER CRANKCASE SEAL BODY				73949
3	OUTER CRANKCASE SEAL BODY SCREW	0.3	26		73940
4	WASHER				73285
5	CLUTCH SPACER WASHER				73945
6	8T RIM SPROCKET KIT				70949
7	CLUTCH NEEDLE BEARING				73939
8	613GC CLUTCH DRUM ASSEMBLY				71520
9	CLUTCH SPACER WASHER, INSIDE				73941
10	CLUTCH	3.4	295		71419
11	CLUTCH SPRING				73943

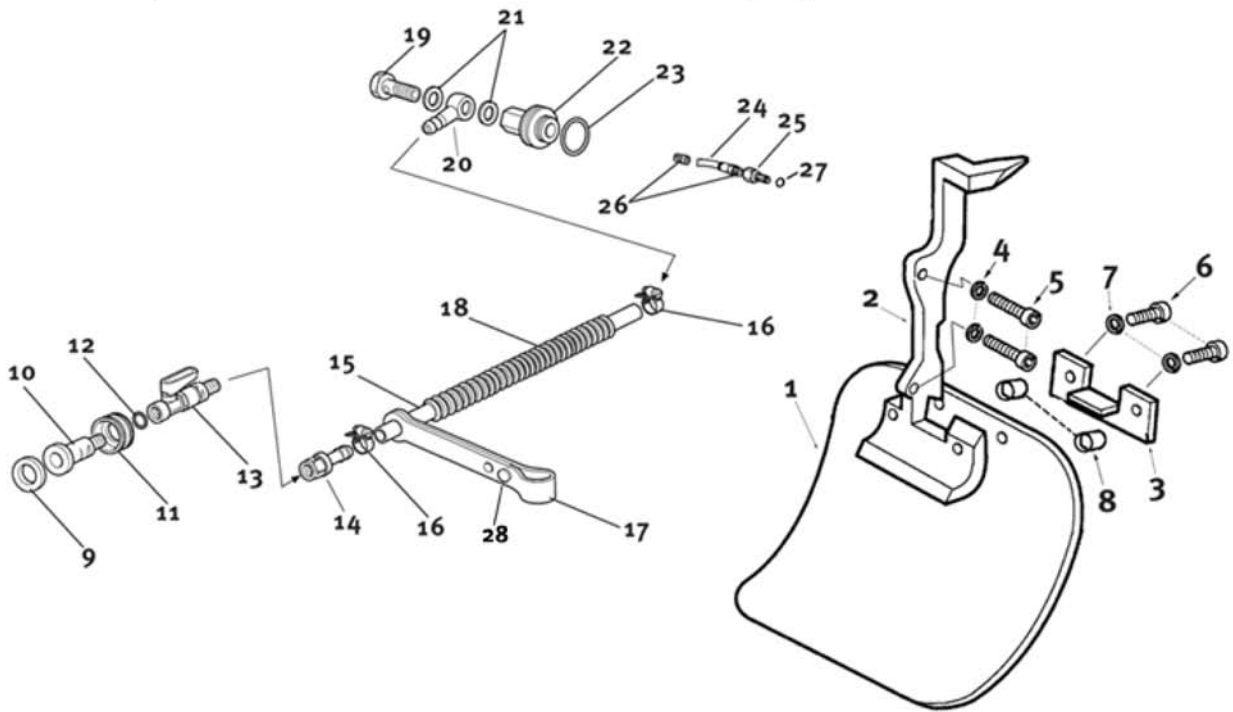

KEY	DESCRIPTION	TORQUE		LOCTITE® 242	PART NUMBER
		Nm	in-lbs.		
1	GUARD FLAP				71534
2	WALLWALKER® LEVER ARM				71532
3	GUARD FLAP CLAMP				71531
4	WASHER				73951
5	WALLWALKER® LEVER ARM SCREW	0.5	43	X	71478
6	GUARD FLAP SCREW	0.5	43	X	71479
7	GUARD FLAP WASHER				71483
8	GUARD FLAP SPACER				71480
9	WATER HOSE GASKET				71469
10	FITTING				71467
11	RING NUT				71457
12	WATER HOSE O-RING				71468
13	WATER SHUT-OFF VALVE				71458
14	FITTING				71454
15	WATER HOSE				71455
16	HOSE CLAMP				71465
17	HOSE HANGER				71461
18	WATER HOSE COVER				71464
19	WATER HOSE SCREW	2.0	174		71463
20	FITTING				71453
21	COPPER WASHER				71456
22	WATER TANK CAP				73923
23	FUEL CAP O-RING				73448
24	TUBE				71459
25	FITTING				71470
26	FITTING				71471
27	O-RING				71472
28	HOSE HANGER BUTTON				71744

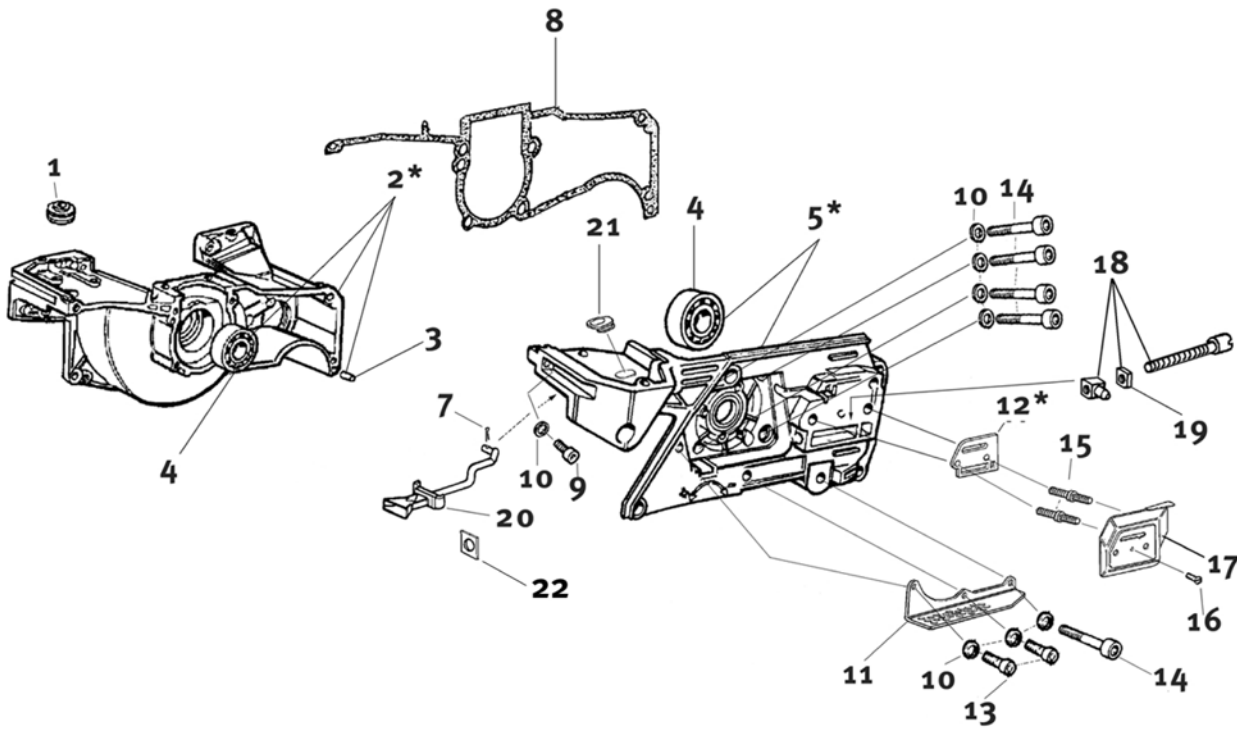

KEY	DESCRIPTION	TORQUE		LOCTITE® 242	PART NUMBER
		Nm	in-lbs.		
1	FUEL LINE GROMMET (CRANKCASE)				73390
2	CRANKCASE ASSEMBLY, LEFT HALF				71736
3	CRANKCASE DOWEL PIN				73281
4	CRANKSHAFT BEARING				73209
5	CRANKCASE ASSEMBLY, RIGHT HALF				71747
7	CHOKE LEVER SPLIT PIN				73927
8	CRANKCASE GASKET				73934
9	CRANKCASE BOLT	0.8	69	X	73930
10	WASHER				73897
11	BOTTOM COVER				73950
12	BAR MOUNT PAD SPACER				71740
13	COVER GUARD MOUNTING BOLT	0.8	69	X	73397
14	SCREW (CRANKCASE)	0.5	43	X	73379
15	BAR MOUNTING STUD	1.2	104		73933
16	SCREW	0.8	69		73284
17	BAR MOUNT PAD COVER PLATE				71738
18	PREMIUM TENSIONER KIT (REPLACES 73283), ASSEMBLY				73935
19	TENSIONER SCREW RETAINER				73936
20	CHOKE LEVER				73928
21	CRANKCASE GROMMET, RIGHT SIDE				71741
22	CHOKE LEVER BUSHING				73955

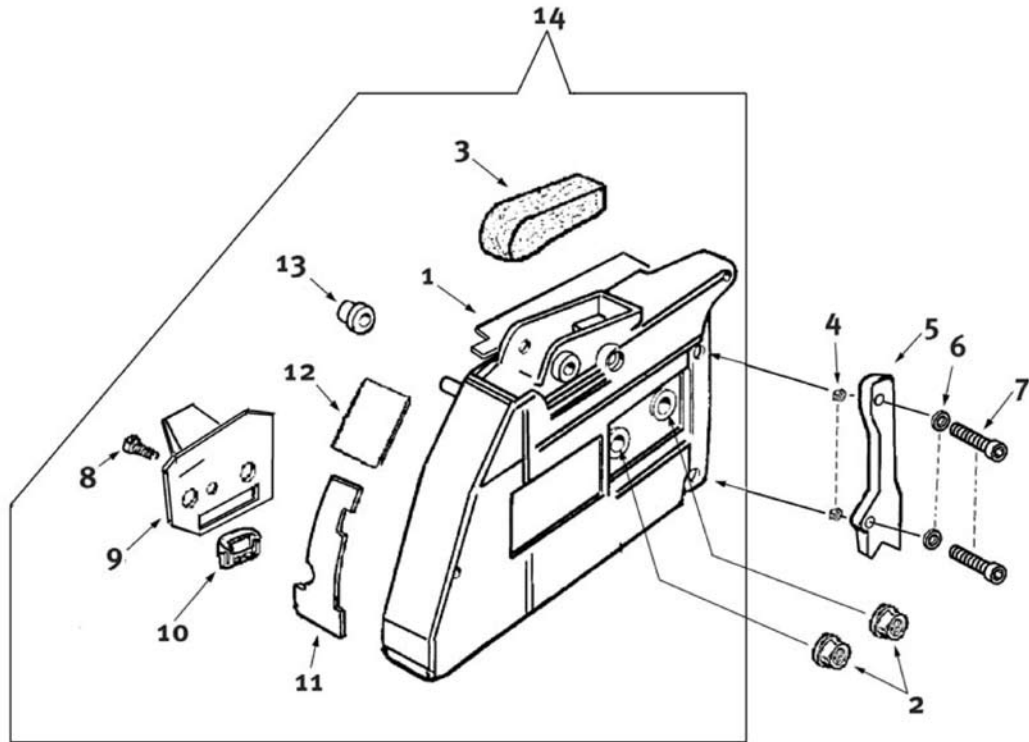

KEY	DESCRIPTION	TORQUE		LOCTITE® 242	PART NUMBER
		Nm	in-lbs.		
1	SIDE COVER INSERT, TOP				71743
2	SIDE COVER NUT	1.2	104		73958
3	CHAIN COVER CAP				71462
4	MOUNTING NUT				73367
5	WALLWALKER® SIDE ARM				71533
6	WASHER				73951
7	WALLWALKER® SIDE ARM SCREW				507355
8	SCREW	0.3	26	X	71487
9	SIDE COVER PLATE				71447
10	LOWER GUARD				73957
11	SIDE COVER INSERT, BOTTOM REAR				73972
12	SIDE COVER INSERT, TOP REAR				73948
13	SIDE COVER GROMMET				73310
14	SIDE COVER ASSEMBLY, COMPLETE				71420

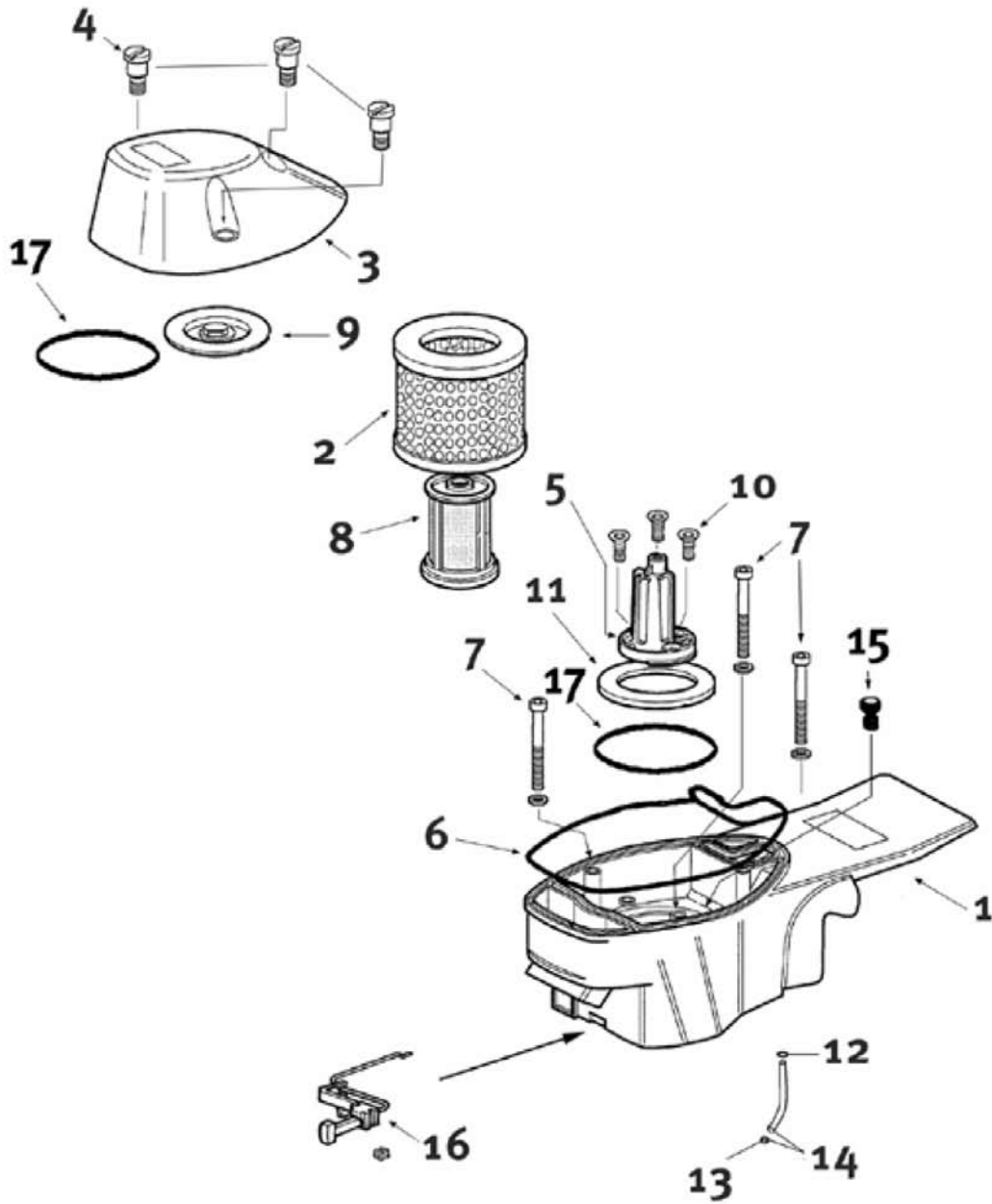

KEY	DESCRIPTION	TORQUE		LOCTITE® 242	PART NUMBER
		Nm	in-lbs.		
1	CYLINDER COVER ASSEMBLY, WITH AIR INTAKE				71754
2	AIR FILTER CANNISTER, POLYESTER				71752
3	AIR FILTER COVER ASSEMBLY, 3 SCREW				71753
4	FILTER COVER SCREW				73992
5	FILTER SUPPORT				73338
6	FILTER COVER GASKET				71756
7	SCREW, CYLINDER COVER, LONG, SOCKET HEAD	X	X	X	71771
8	PREFILTER PLASTIC, SECONDARY FILTER				73336
9	AIR FILTER FLANGE				71758
10	FILTER SUPPORT SCREW	0.3	26	X	73337
11	FILTER CANNISTER GASKET				73335
12	O-RING				71472
13	TUBE CLAMP, NO TABS				71760
14	COMPENSATOR TUBE				71775
15	BREATHER GROMMET				71763
16	THROTTLE ASSEMBLY				71750
17	O-RING, AIR FILTER				73331

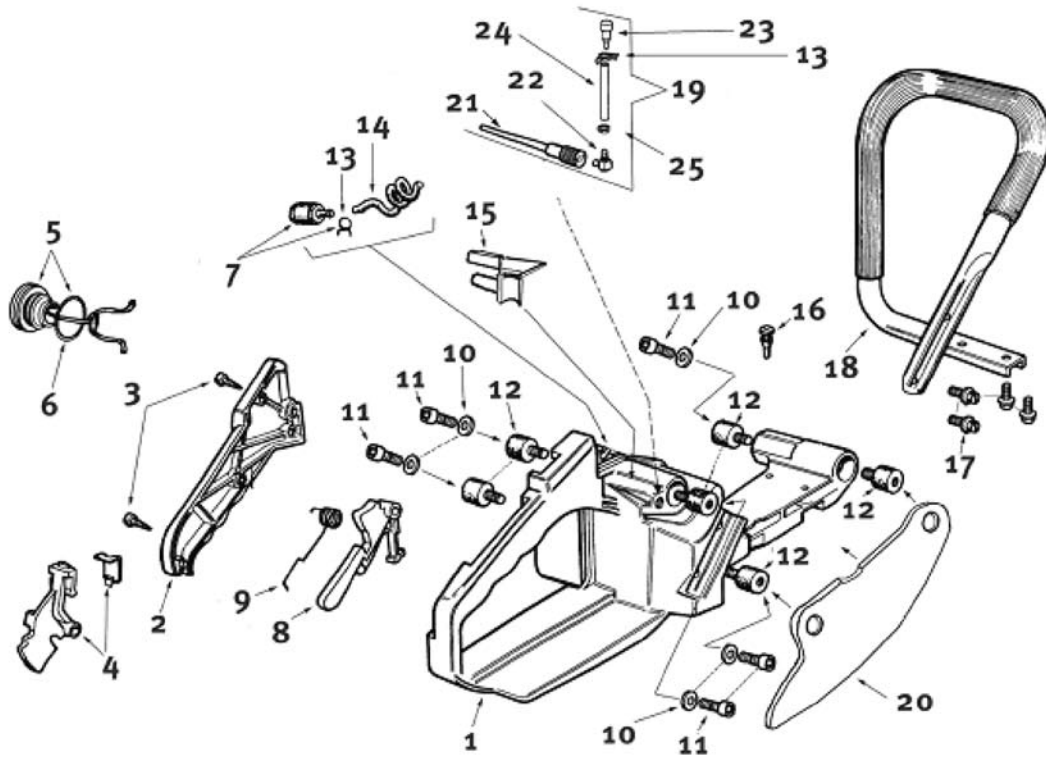

KEY	DESCRIPTION	TORQUE		LOCTITE® 242	PART NUMBER
		Nm	in-lbs.		
1	FUEL TANK ASSEMBLY (REQUIRES P/N 71739)				71421
2	REAR HANDLE HALF				73975
3	SCREW	0.1	9		73976
4	THROTTLE LEVER				71749
5	FUEL CAP ASSEMBLY, WITH OUTER SEAL RING				71739
6	FUEL CAP O-RING				73448
7	FUEL FILTER				73459
8	TRIGGER LOCKOUT LEVER				73987
9	TRIGGER LOCKOUT LEVER SPRING				73988
10	WASHER				73897
11	SCREW	0.9	78	X	73982
12	SHOCK ABSORBER	0.4	35		73980
13	TUBE CLAMP, WITH TABS				71588
14	FUEL LINE				73375
15	SHOCK ABSORBER, REAR HANDLE				71745
16	BUMPER, SHOCK ABSORBER, FUEL TANK TOP				73270
17	FRONT HANDLE BOLT	0.8	69	X	73983
18	FRONT HANDLE				71422
19	FUEL BREATHER COMPLETE				71748
20	WATER DEFLECTOR, BOTTOM				71766
21	BREATHER TUBE BODY				71751
22	BREATHER TUBE ELBOW				71759
23	FUEL BREATHER, REMOTE				71761
24	BREATHER TUBE EXTENSION				71777
25	TUBE CLAMP, NO TABS				71760

- 5** This section covers the disassembly, inspection, and assembly air induction system.
- 5.1** Loosen the air filter cover screws and remove air filter cover.



- 5.2** Remove air filter from cover.
- A** Inspect air filter.
 - B** Replace if necessary



- 5.3** Clean filter with cleaning solution and a nylon brush.
- A** Clean filter with cleaning solution and water.
 - B** Let dry and reinstall.



- 5.4 Inspect air filter cover gasket.
- A Replace if permanently depressed or hard due to slurry.
- 5.5 Inspect filter cannister gasket.
- A Clean.
 - B Replace if necessary.

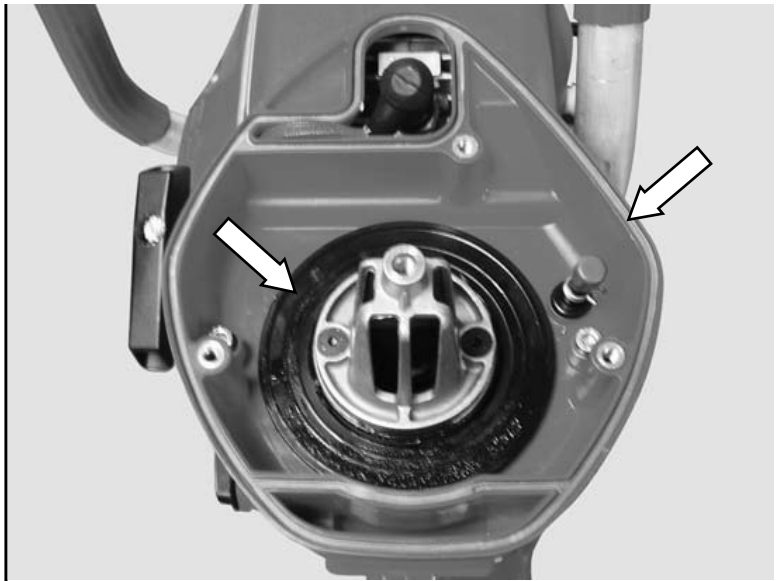

- 5.6 Secure air filter mount screws.

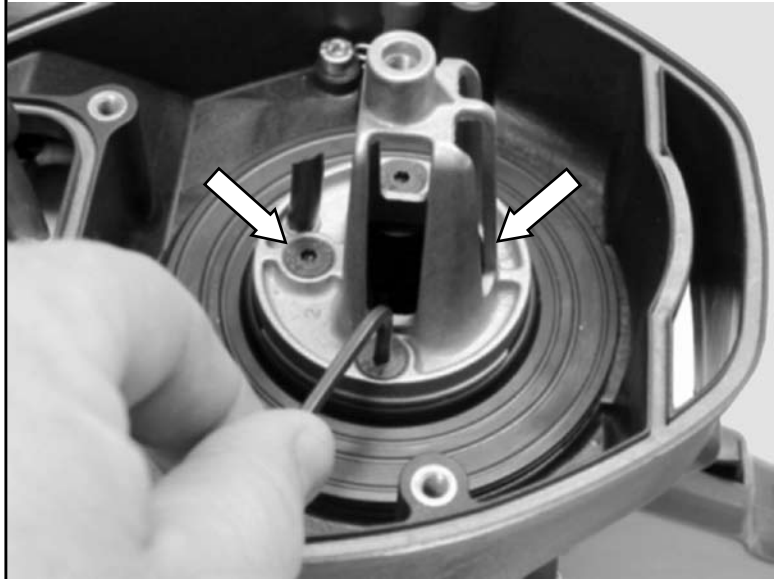

6 This section covers the removal, inspection, and installation of the spark plug.

- 6.1 Remove the spark plug lead.
- 6.2 Clean area around the spark plug to prevent debris from entering the cylinder.

6.3 Remove the spark plug.

6.4 Inspect the spark plug.

- A If dirty, clean with a wire brush as shown.



B Gap if necessary to 0.02" (0.5 mm).

NOTE: If the spark plug must be replaced refer to the Spark Plug Reference Guide on page 78 to select the correct replacement plug.

6.5 Assemble in the reverse order.

A Make sure the plug boot is seated completely.



7 This section covers clutch removal, rim sprocket removal, inspection, and assembly. Refer to sections 5 and 6 if needed.

7.1 Insert piston stop tool into spark plug hole.



7.2 Pull starter handle until piston stops against tool.



7.3 Remove clutch.

⚠ Left hand threads – rotate clockwise to loosen.

NOTE: If an impact wrench is available steps 7.1 and 7.2 do not have to be performed.

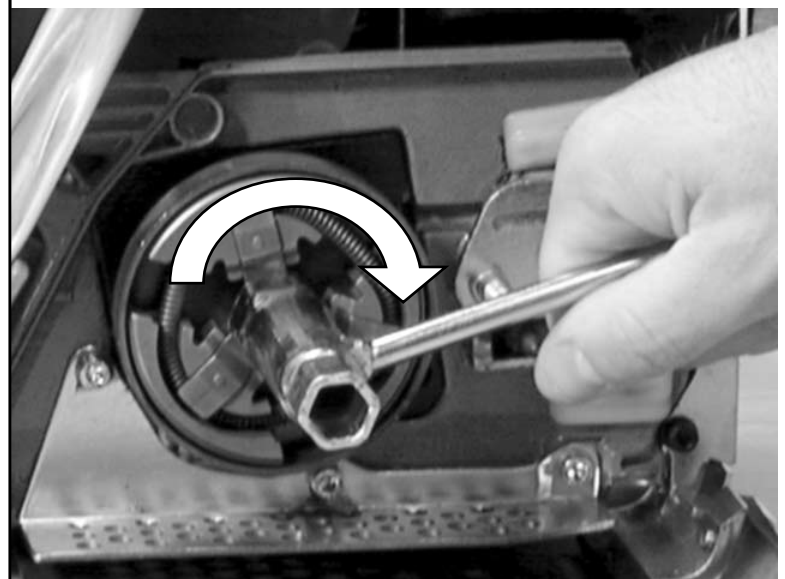

7.4 Remove all drive components.



7.5 Inspect the clutch shoes for wear.
A Replace if the shoe has less than 0.04" (1 mm) of material, as shown.



7.6 Inspect spring for cracks.

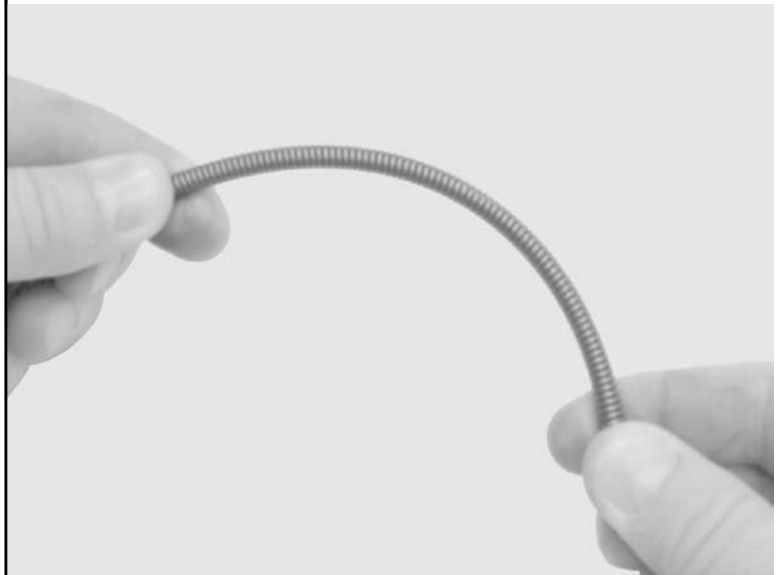

7.7 Assemble clutch shoes as shown.

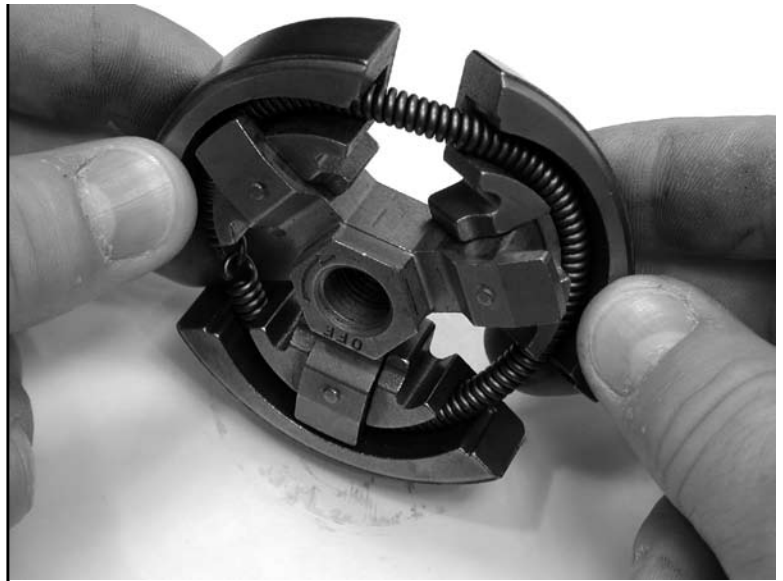

7.8 Finish installation of clutch shoe as shown.

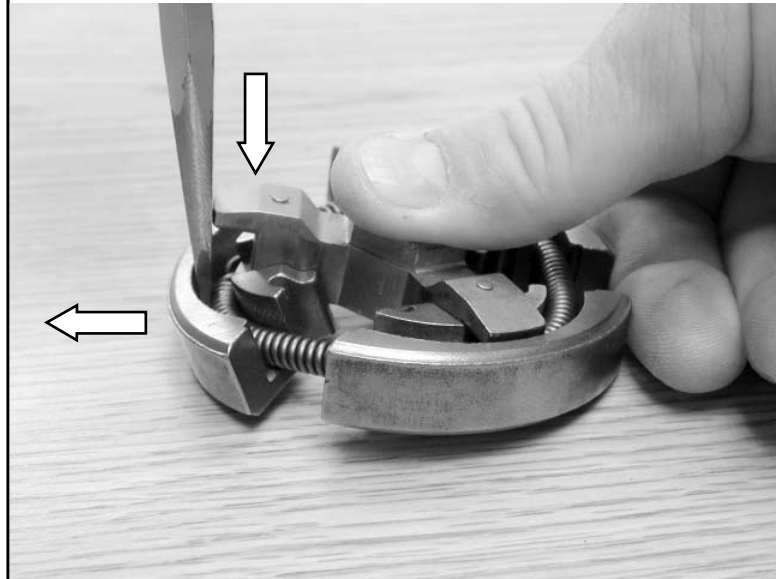

7.9 Inspect the rim sprocket for wear.

- A Replace if the rim sprocket teeth are worn to points, as shown on right.



7.10 Clean and assemble.

- A Clean all parts in solvent.
- B Grease clutch cup bearing with a water proof grease (ICS® P/N 70885).
- C Assemble clutch spacer washer, bearing, clutch cup with rim sprocket, and inside clutch spacer washer.



7.11 Install clutch.

- A Tighten firmly
 - ⚠ Left hand threads

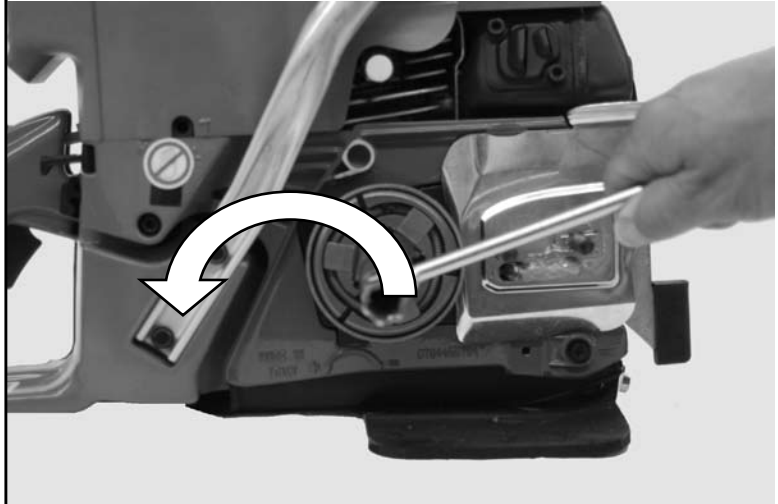

8 This section covers the removal of the starter cover, replacement of the starter rope, and replacement of the recoil spring.

8.1 Remove starter cover screws.

8.2 Remove starter cover assembly from saw.

8.3 Remove starter cord shield screws.

8.4 Relieve spring tension.

A Pull 4-6" of rope out.

B Line rope up with notch on pulley.

C Slowly rotate pulley counterclockwise until spring pressure is released. Use thumb as a brake.

8.5 Remove starter pulley screw and washer.

NOTE: Hold starter cover firmly.

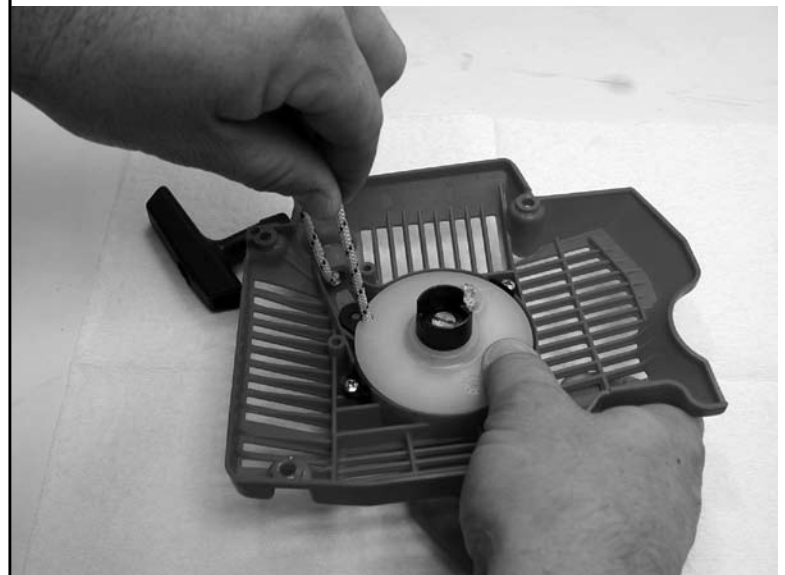

8.6 Remove starter pulley.

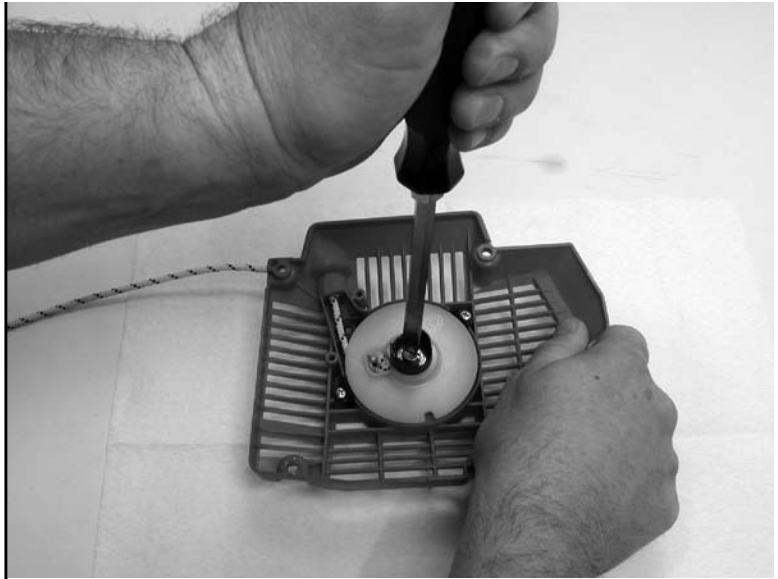

8.7 Inspect coil spring.

A Replace if spring hook is damaged. Attempting to re-bend the spring hook may cause the hook to break off.

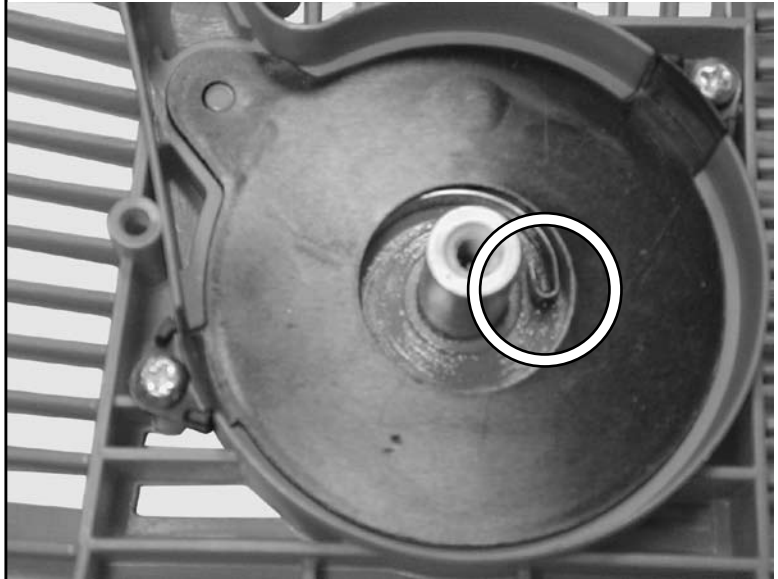

B Carefully remove coil spring and housing to prevent spring from unwinding.

8.8 Lubricate with light weight oil.

8.9 Replace parts carefully.

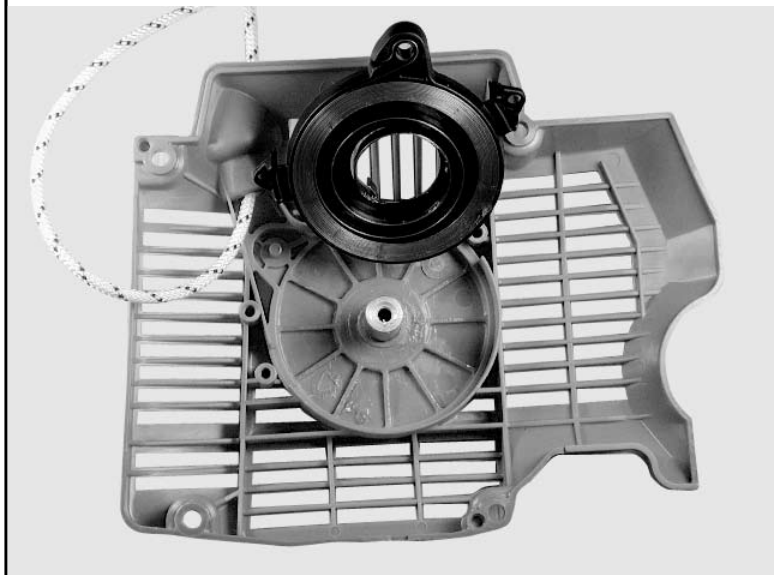

- 8.10 Inspect pulley spring catch.
- A Clean with cleaning solution.
 - B Replace if worn or broken.



- 8.11 Install starter rope and tie knot.

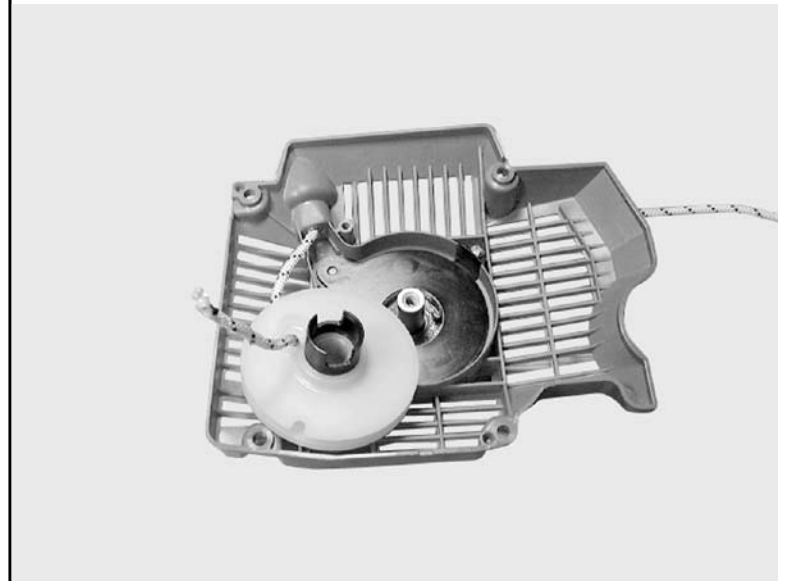

- 8.12 Install pulley
- A Wind rope onto pulley clockwise leaving 4-6" out.
 - B Make sure that the pulley spring catch is in the spring hook.
- 8.13 Install center screw.
- A Use blue Loctite®.
 - B Torque to 26 in-lbs. (2.9 Nm).

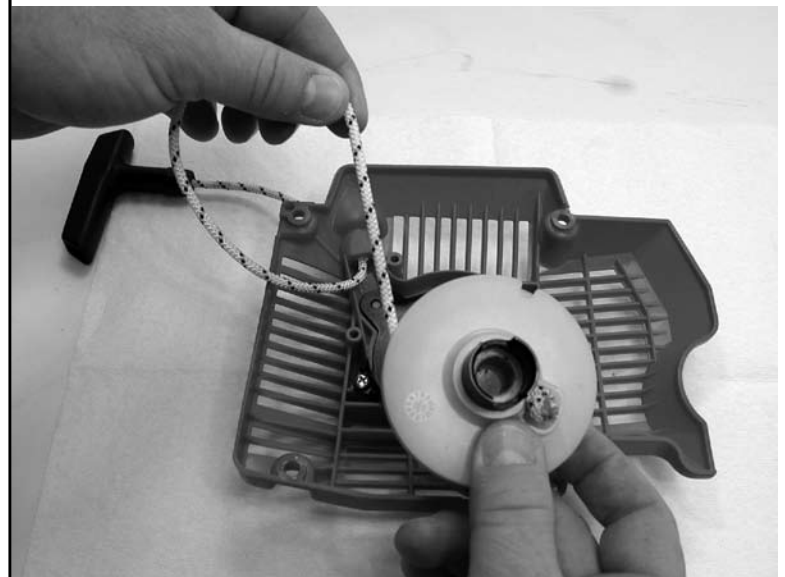

- 8.14 Wind the recoil spring.
- A Line rope up with notch on pulley.
 - B Rotate the pulley with the rope clockwise 5 times.
 - C Untangle rope and release.

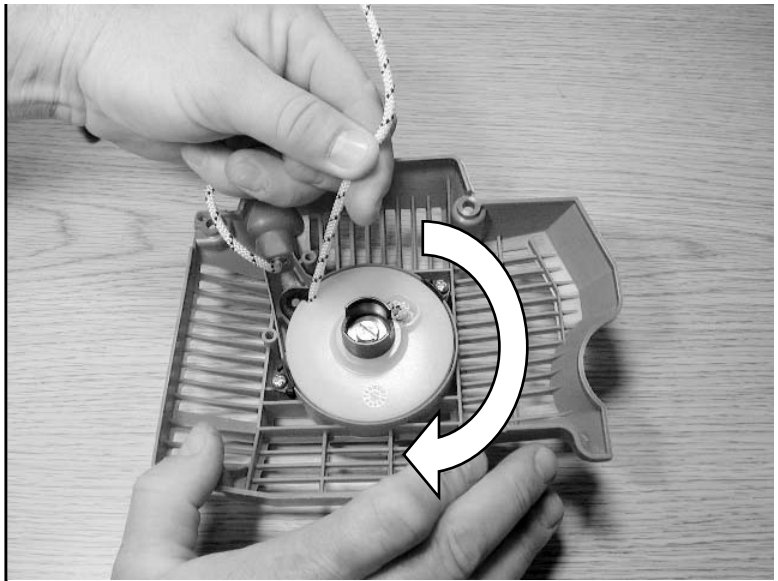

- 8.15 Assemble starter cord shield.



- 8.16 Remove starter pawl screws, pawls, spring, and plain washer.
- 8.17 Inspect and clean pawl components.
- A Inspect the components. Replace if necessary.
 - B Clean the components with a brush and solvent.



8.18 Assemble components

- A Make sure the spring is in the correct position.
- B Use blue Loctite® on the pawl screws.
- C Torque to 60 in-lbs. (6.8 Nm).

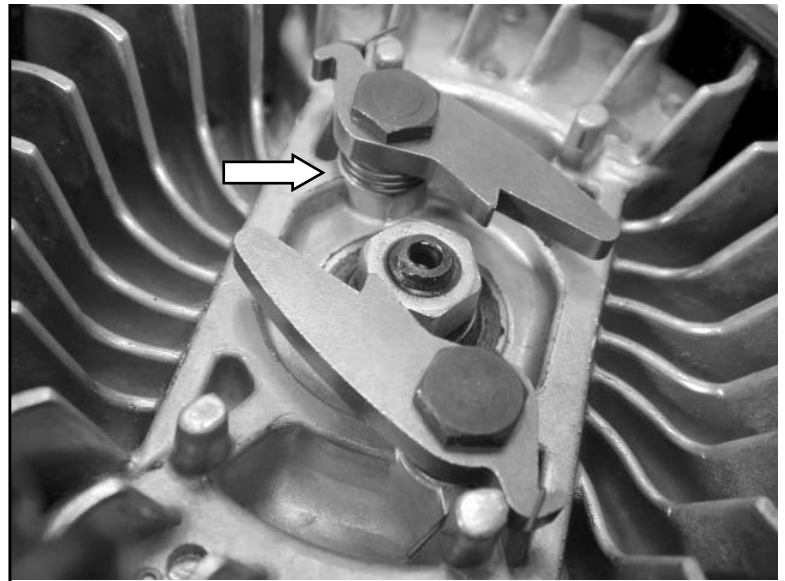

8.19 Wind the pawl spring.

- A Use needle nose pliers to move the tail of the spring into position.

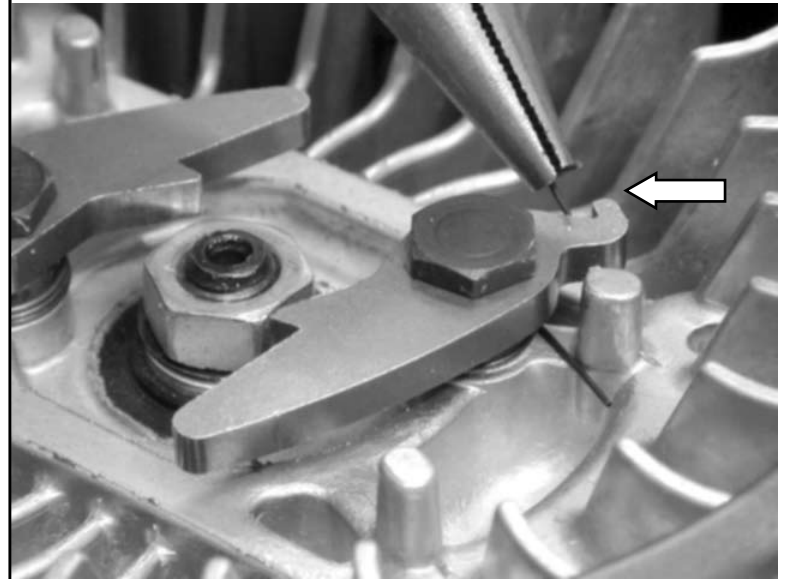

8.20 Install starter cover.

- A Pull out cord 4-6".
- B Slowly release while placing cover to allow pawls to engage.

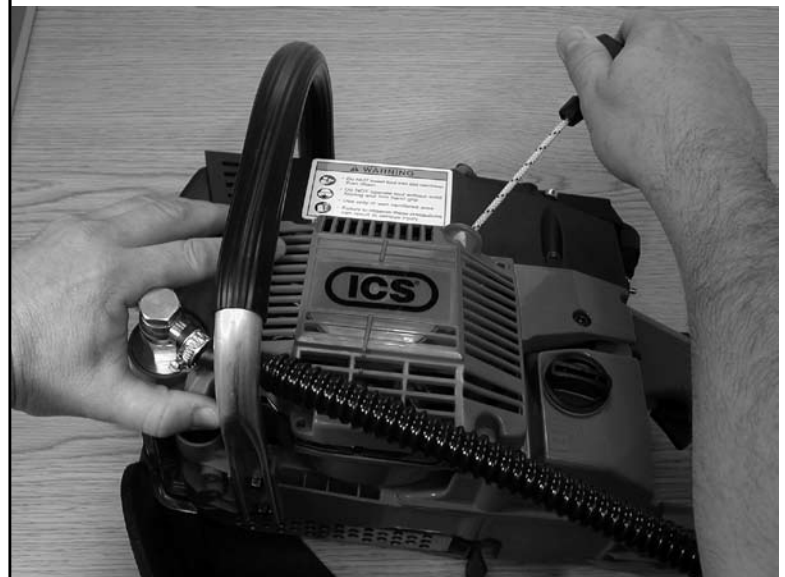

- 8.21 Install starter cover screws.
- A Use blue Loctite®.
 - B Torque to 60 in-lbs. (7 Nm).

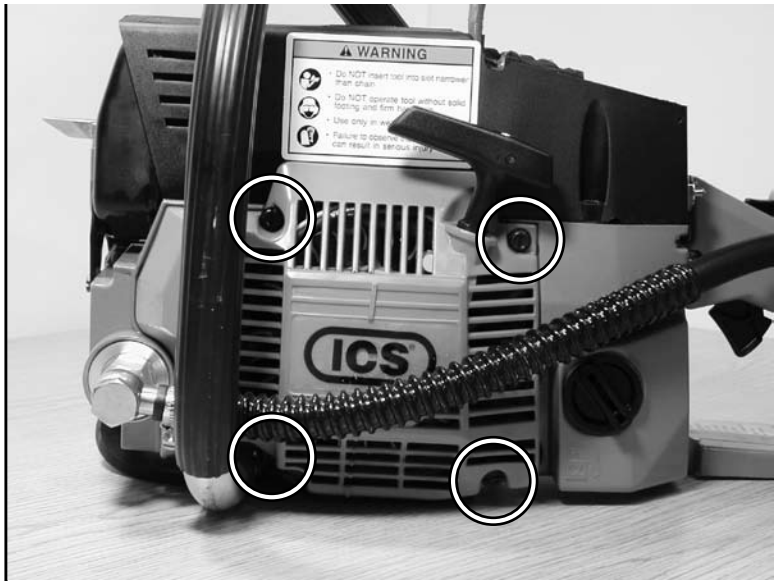

9 This section covers the removal, inspection, and assembly of the WallWalker® and guard flap.

9.1 Inspect WallWalker® tip.

A If the tip is worn, as shown, replace.

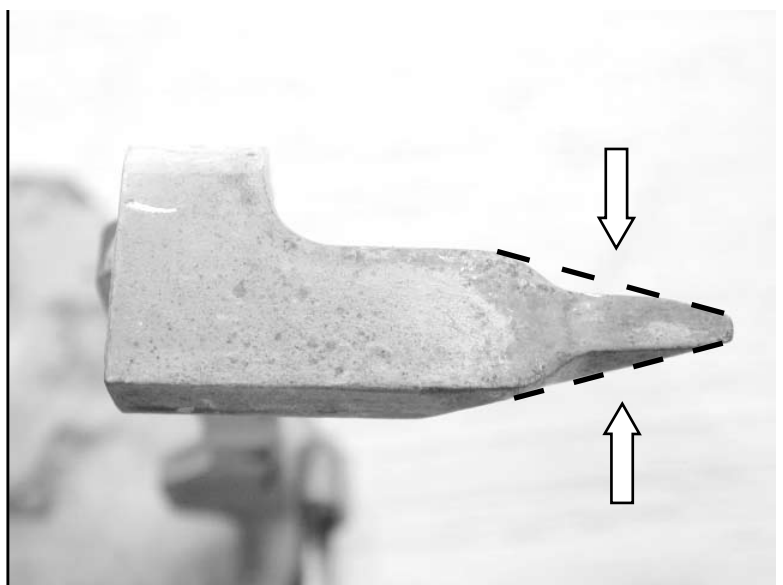

9.2 Remove crankcase screws and wave washers.

9.3 Remove WallWalker® from saw.

NOTE: On late model saws it is necessary to remove the bar plate prior to removing the crankcase screws.

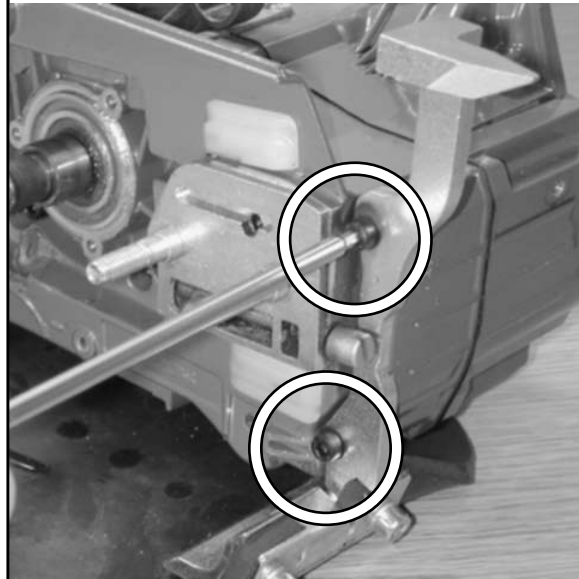

9.4 Remove guard flap screws and washer.

9.5 Remove and inspect guard flap.

A Replace the flap if it is torn or damaged in any way.

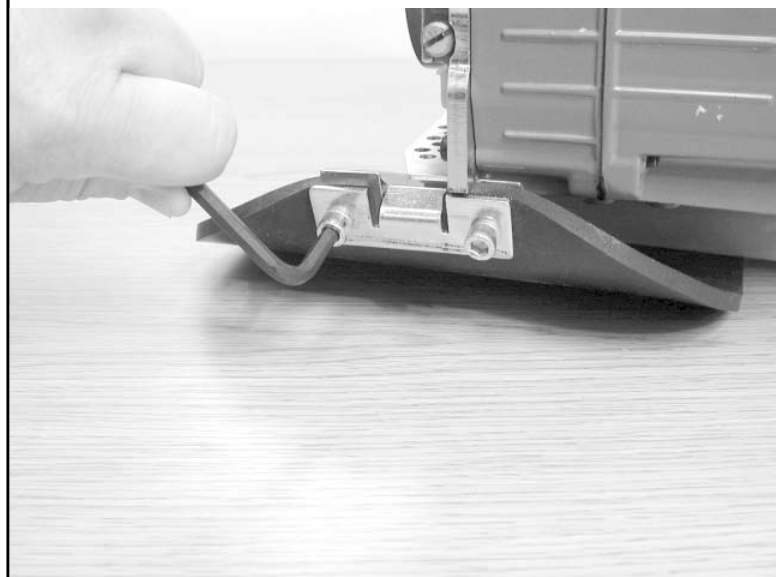

- 9.6 Reassemble in the reverse order.
- A Install crankcase screws and wave washers.
 - B Use blue Loctite®.
 - C Torque to 70 in-lbs. (7.9 Nm).

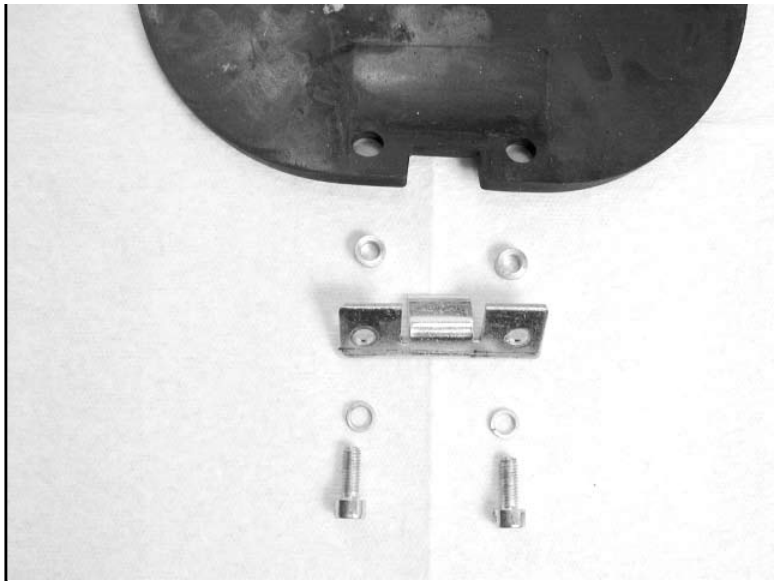

10 This section covers the disassembly and assembly of the cylinder cover. Removal of the air intake components and front handle is necessary. Refer to sections 1 and 14 if needed.

10.1 Remove the air filter mount screws.

10.2 Remove the cylinder cover screws (3).

10.3 Remove spark plug lead from cylinder cover.

10.4 Remove fuel tank breather cap and clamp.

10.5 Partially remove intake manifold from cylinder cover.

10.6 Remove cylinder cover.

A Pull up on front.

B Push intake manifold through hole.

C Make sure throttle linkage is disengaged from cylinder cover.

D Guide fuel breather tube and compensator tube through cylinder cover.

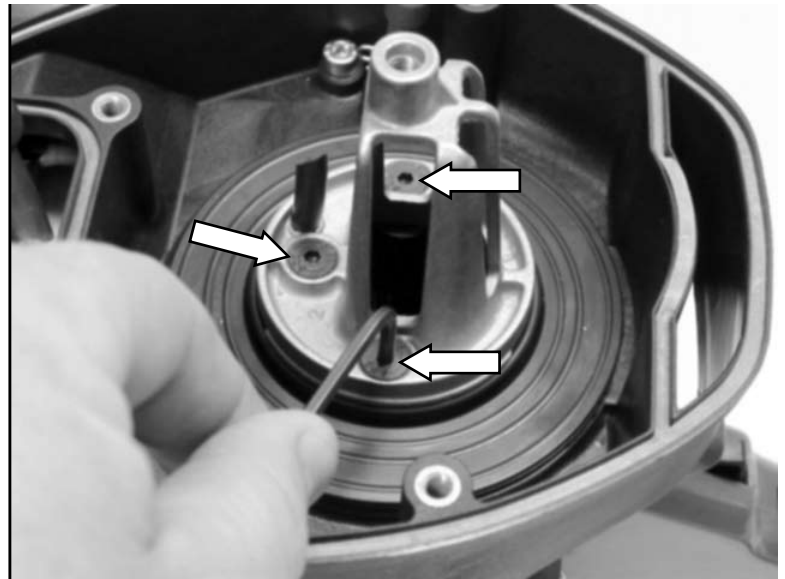

- 10.7 Remove stop switch leads.
- 10.8 Inspect cylinder cover for damage.
 - A Replace if necessary.

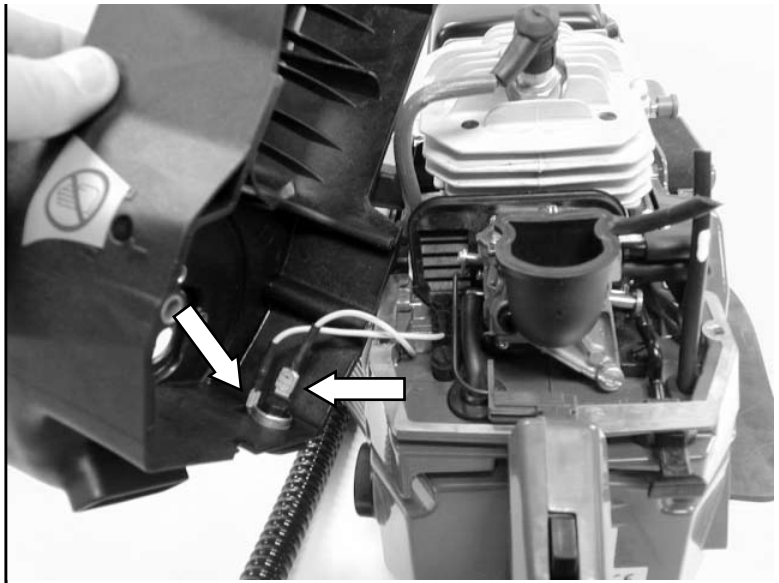

- 10.9 Check cylinder cover water seal and filter cover gasket are in place and in good condition.
 - A Replace if necessary.
- 10.10 Reassemble stop switch leads.



- 10.11 Make sure carburetor screw boot is in place.
- 10.12 Lubricate compensating tube and fuel tank breather tube with soapy water, guide through cylinder cover (Install compensating tube first).

NOTE: Be careful as to not pull tubes away from their point of connection. Approximately 3/4" of tube should protrude from cylinder cover.

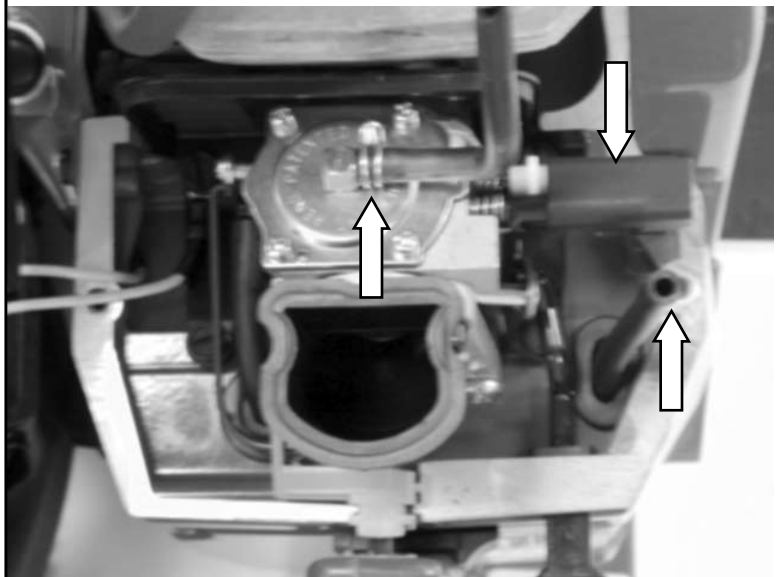

- 10.13 Install cylinder cover.
- Pull spark plug lead into slot in cylinder cover.
 - Align throttle linkage with cylinder cover and crankcase.
 - Push the cylinder cover down on the crankcase, guide intake manifold into cylinder cover.
 - Install the cylinder cover screws. Use blue Loctite®. Torque to 35 in-lbs. (4.0 Nm).
 - Install fuel tank breather and clamp.



- 10.14 Install air filter mount.
- Guide carburetor compensating tube through air filter mount. Make sure manifold sits flat over lip on cylinder cover.
 - Install air filter mount screws (3) using blue Loctite®.
 - Torque to 43 in-lbs. (4.9 NM).

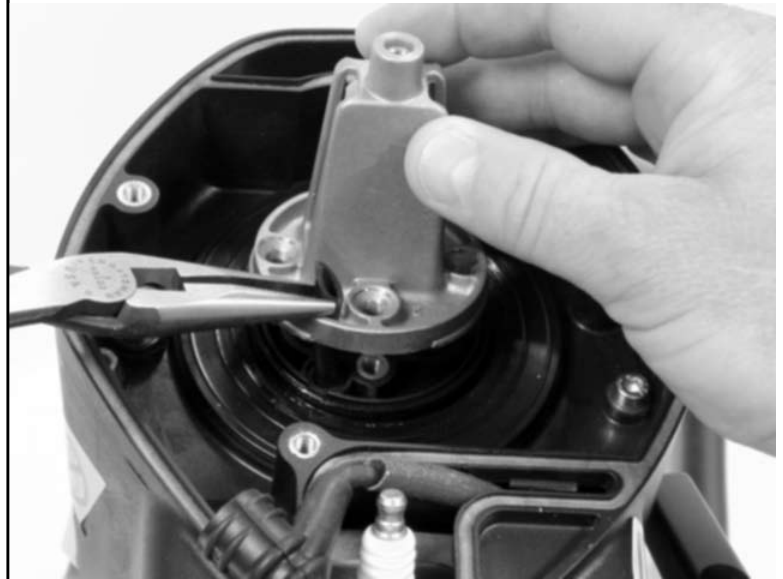

- 10.15 Install air filters and cover.
- Install pre-filter
 - Install clean air filter
 - Install air filter flange and tighten
 - Install air filter cover and tighten



11 This section covers the disassembly, inspection, and assembly of the muffler. Removal of the WallWalker® and cylinder cover is necessary. Refer to sections 7 and 10 if necessary.

11.1 Remove muffler support screws.

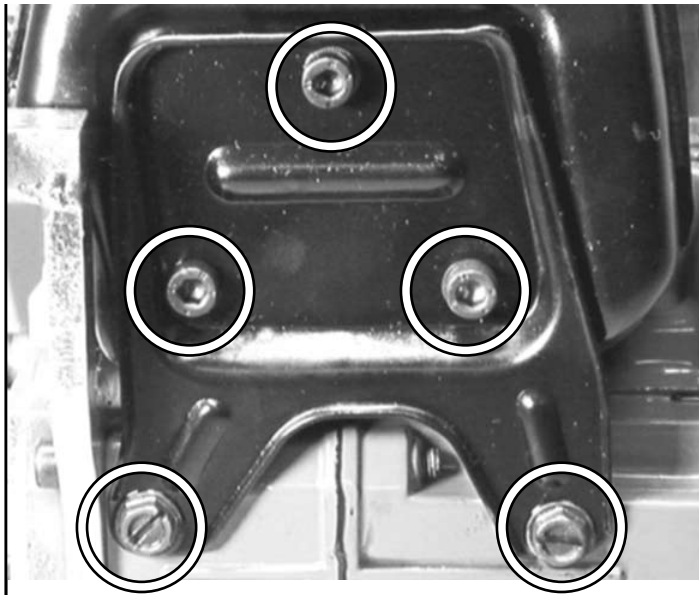

11.2 Remove muffler screws and serrated washers located inside the muffler.

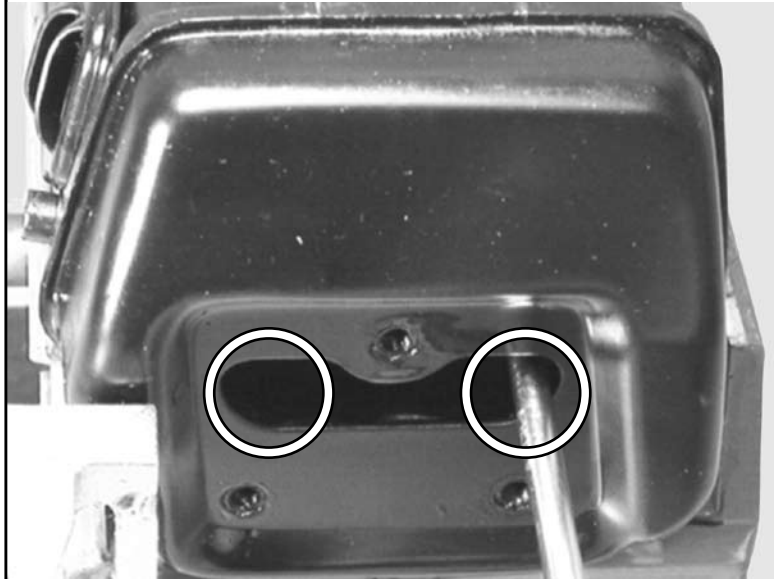

11.3 Remove muffler and heat shield gasket.

A Replace any damaged components.

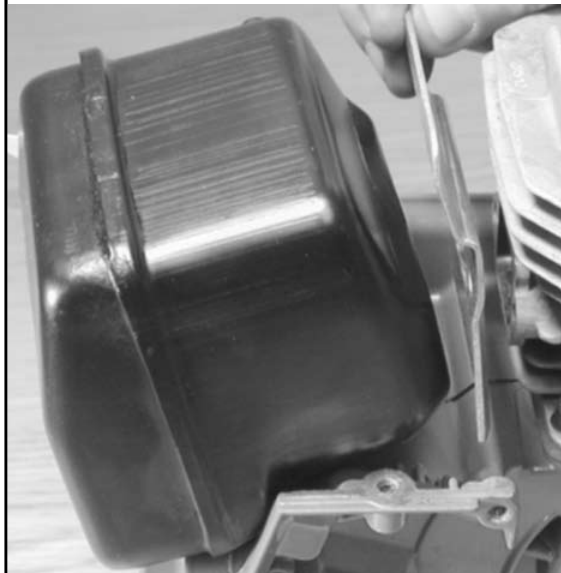

11.4 Install muffler.

- A Insert muffler screws and serrated washer (2) into muffler.
- B Hold muffler screws in place with heat shield gasket.
- C Thread muffler screws into cylinder, torque to 78 in-lbs. (9 Nm).

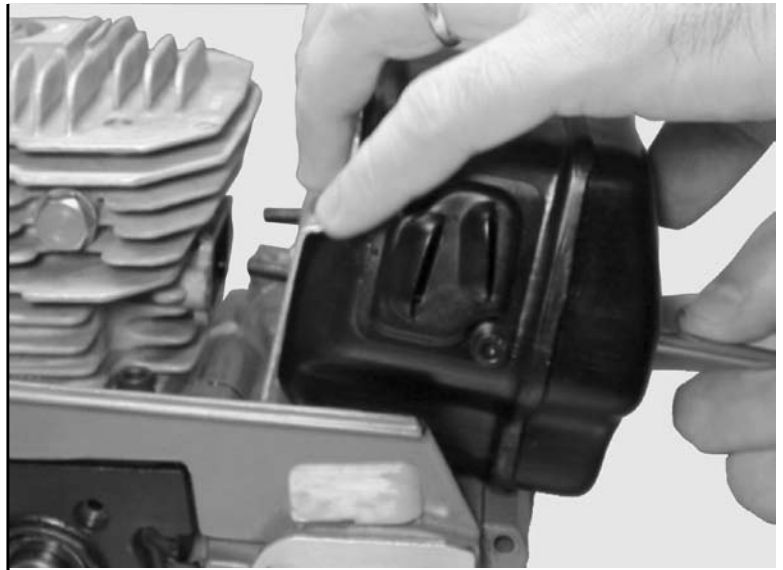

11.5 Install muffler support.

- A Install top 3 muffler support screws and serrated washer finger tight.
- B Install bottom 2 muffler support screws with blue Loctite®.
- C Torque top screws to 78 in-lbs. (9 Nm).
- D Torque bottom screws to 52 in-lbs. (6 Nm).

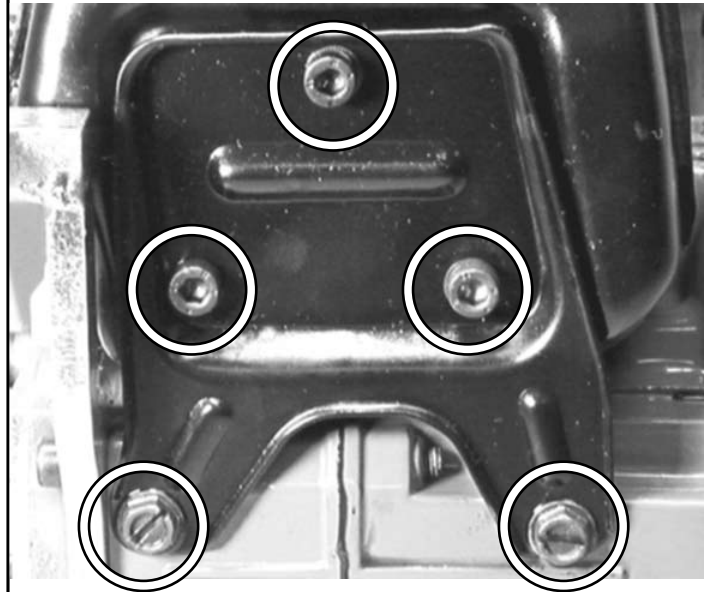

- 12** This section covers the removal and installation of the carburetor. Removal of the air intake components and cylinder cover is required. Please refer to sections 5 and 10 or 11 if necessary. Carburetor tuning is covered in section 23.

NOTE: All saws are equipped with carburetor model # WJ-85A.

- 12.1 Remove throttle linkage.
- A Push trigger end out of rear handle.
 - B Pivot linkage around.
 - C Remove carburetor end of linkage from throttle rod tab on carburetor.



- 12.2 Remove choke lever split pin.
- 12.3 Remove choke lever.
- 12.4 Remove adjustment screw boot.

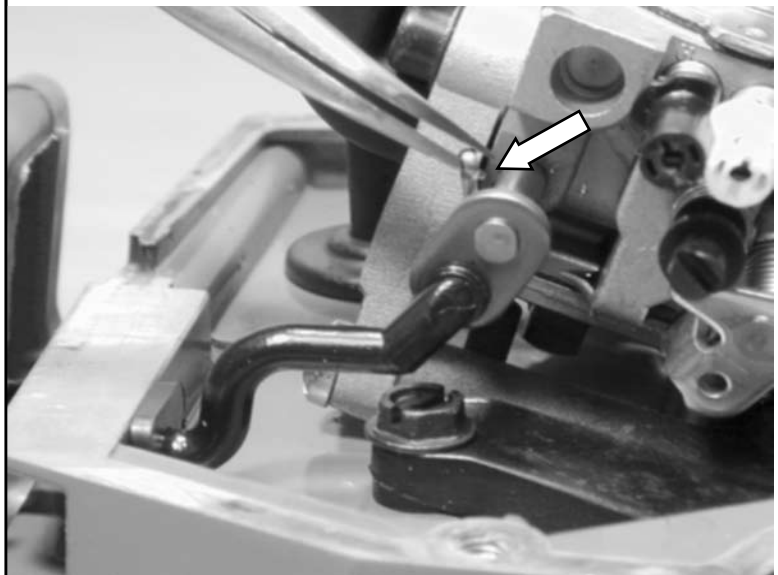

- 12.5 Remove carburetor support screw (1) with #4 Torx or straight blade screwdriver.
- 12.6 Remove carburetor body screws (2).

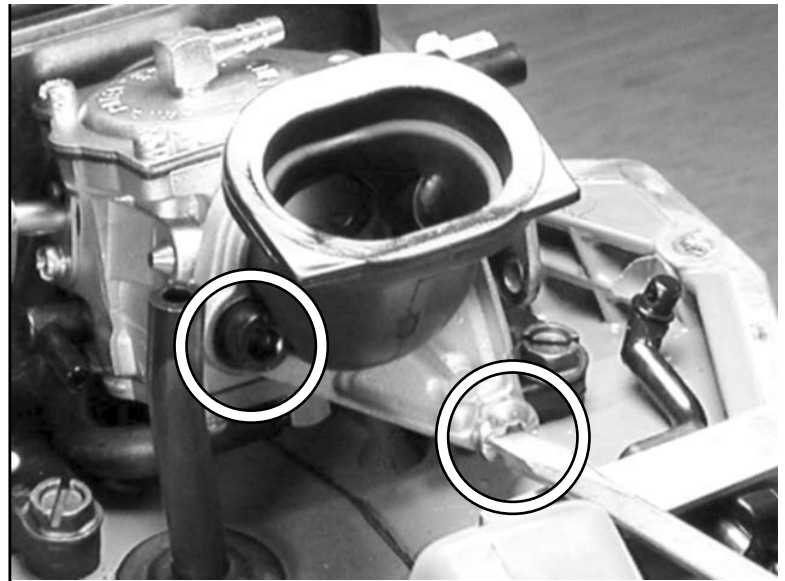

- 12.7 Remove fuel line.
- 12.8 Remove pulse tube.
- 12.9 Remove carburetor compensator tube on top of carburetor.

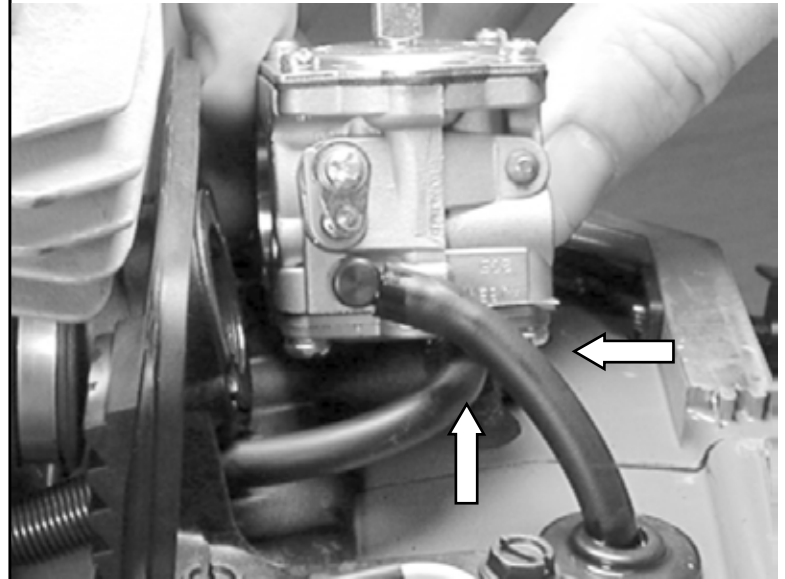

- 12.10 Assemble in the reverse order.
- A Torque carburetor body screws to 43 in-lbs. (5 Nm).
- B Torque supporter screw with blue Loctite® to 43 in-lbs. (5 Nm).

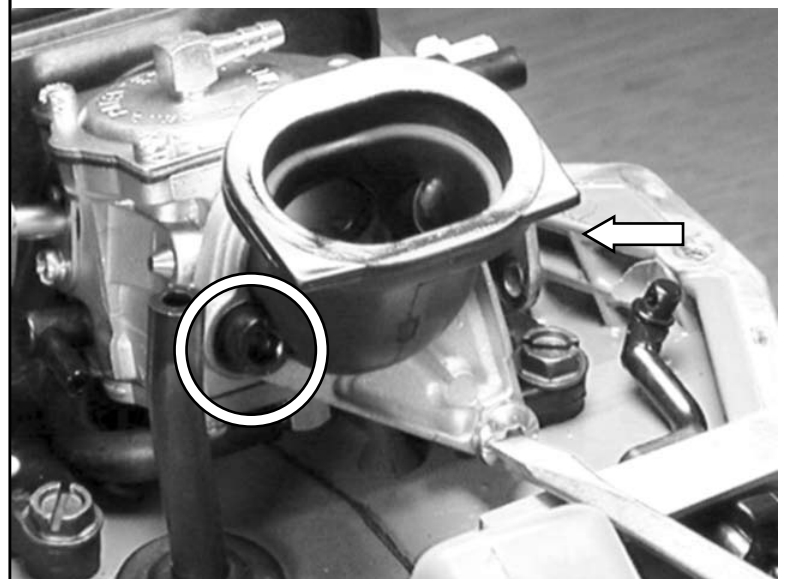

- 13** This section covers the disassembly, inspection and assembly of the cylinder, piston and related components. Removal of several component groups is required. Refer to sections 5, 6, 10, and 12 if necessary.

NOTE: When replacing the 613GC cylinder and piston it is necessary to tune the carburetor prior to returning the saw to service (see section 23).

13.1 Remove carburetor base screws.

- A Remove carburetor base from rear manifold.
- B Remove carburetor base from pulse tube.

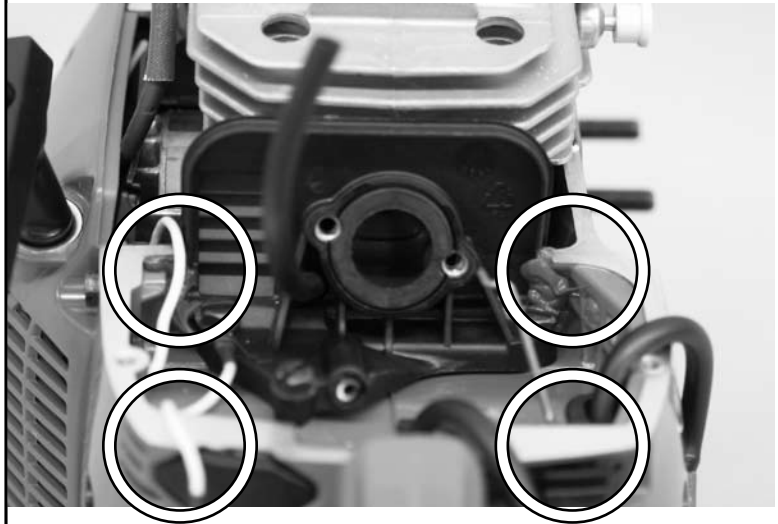

13.2 Remove pulse tube and protective spring from cylinder base.

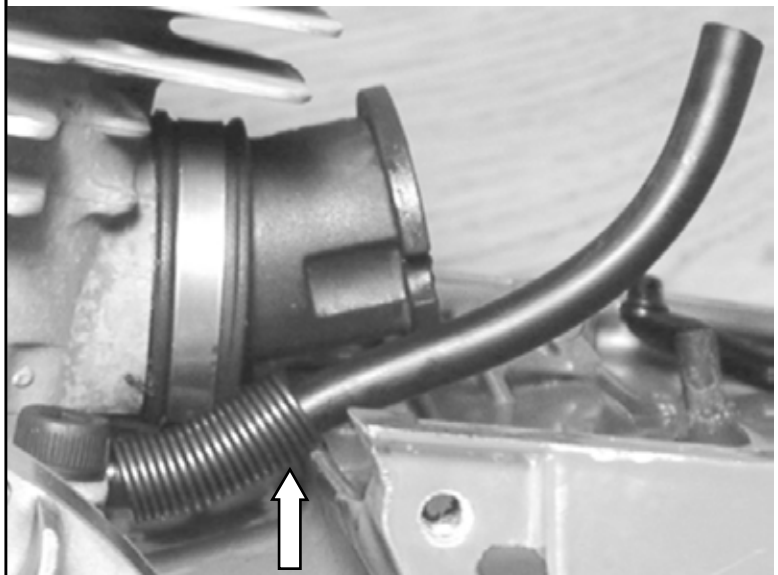

- 13.3 Remove rear manifold clamp.
- 13.4 Remove rear manifold from cylinder.
 - A Inspect for holes and tears.

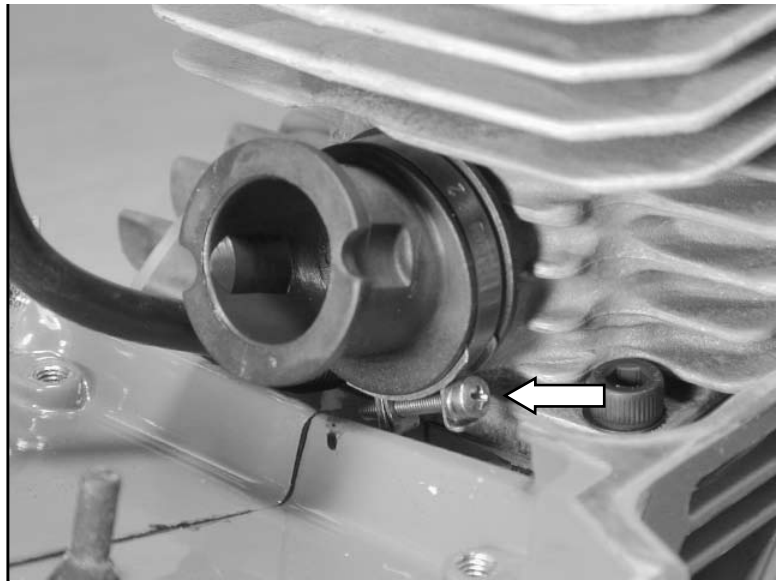

- 13.5 Remove cylinder screws (4) and wave washers.

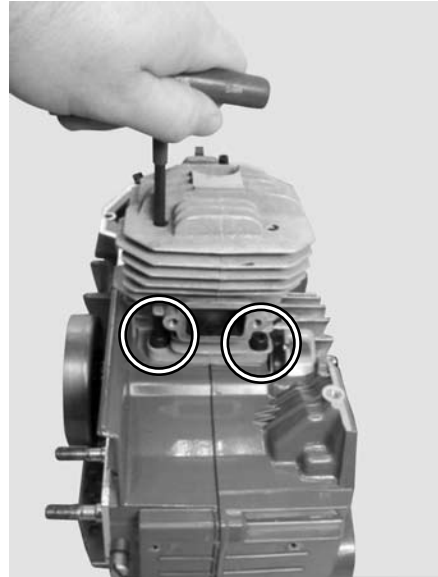

- 13.6 Remove cylinder.
 - A Remove cylinder gasket and clean case.

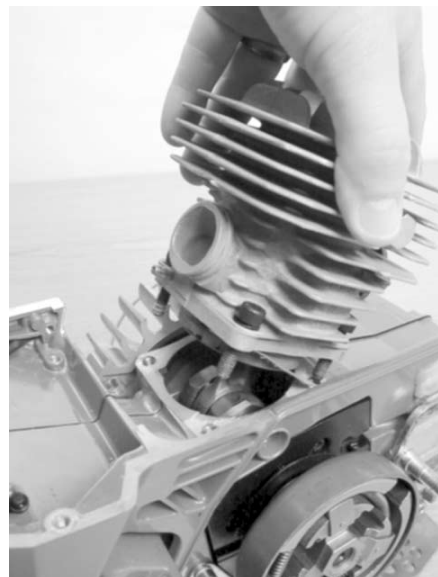

13.7 Remove wrist pin retaining clips (2).



13.8 Press wrist pin out with an 8 mm deep socket.

13.9 Remove piston and inspect. Replace if damaged.



13.10 Remove wrist pin bearing.



13.11 Cylinder gasket

- A Oil gasket with ICS® 2-stroke engine oil.
- B Install and align holes and notch.

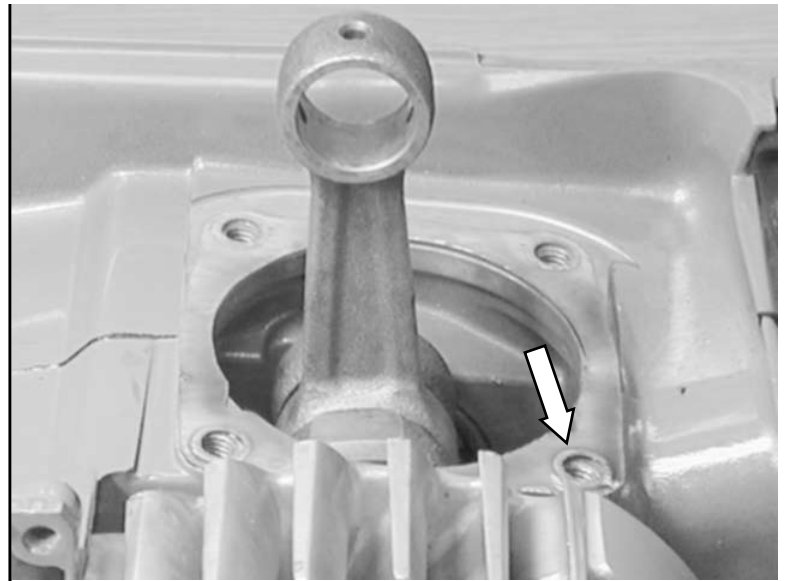

13.12 Install wrist pin bearing in rod.

- A Oil bearing with ICS® 2-stroke engine oil.



13.13 Install rings.



13.14 Ring orientation.

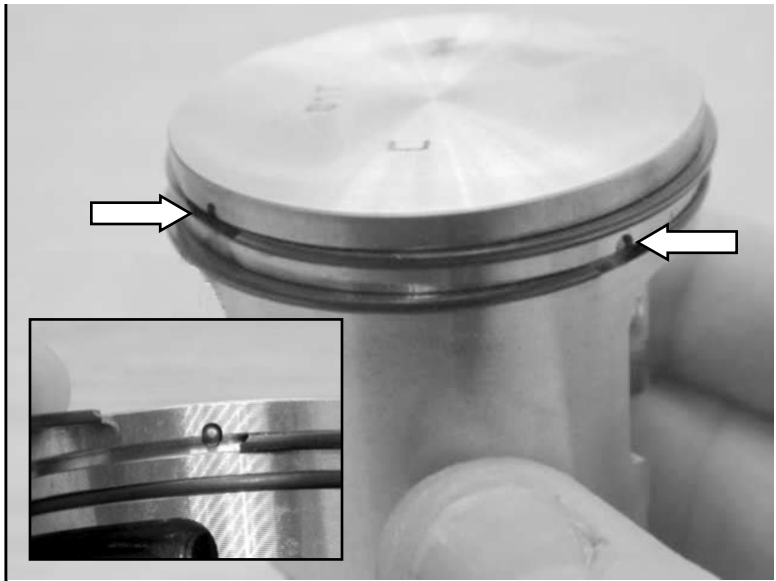

13.15 Install one wrist pin retaining clip.



13.16 Make sure wrist pin retaining clip is in the proper orientation.

- ⚠ Improper installation may result in serious engine damage.

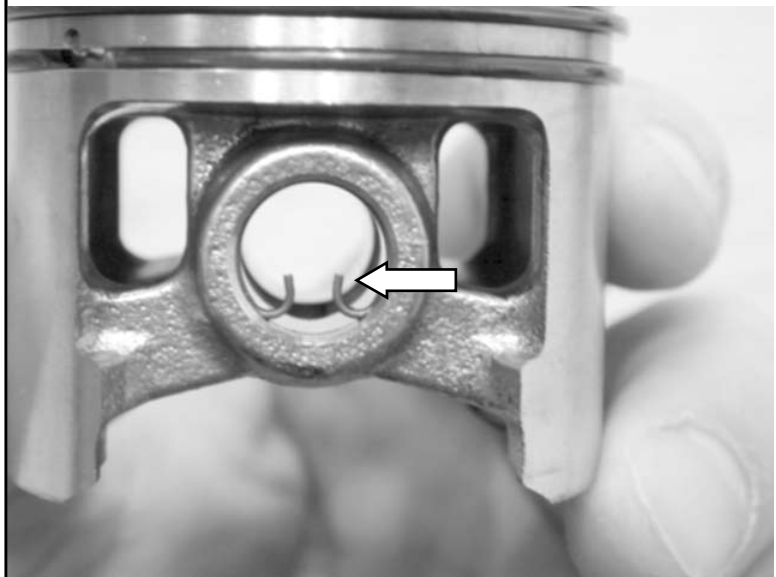

13.17 Partially install wrist pin.



13.18 Align piston in correct orientation.

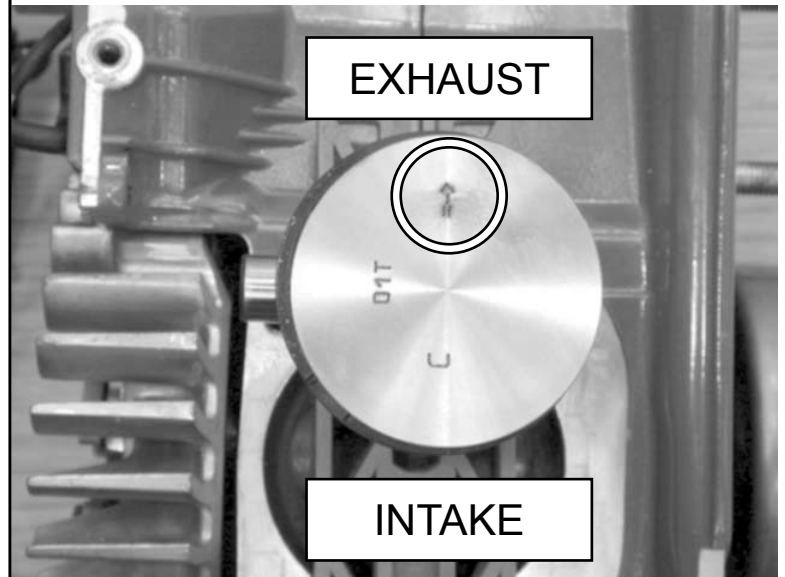

13.19 Install piston.

- A Oil piston with ICS® 2-stroke oil.
- B Align wrist pin with wrist pin bearing.
- C Complete wrist pin installation.
- D Install second wrist pin retaining clip

⚠ Make sure wrist pin retaining clip is in the proper orientation (see 13.16).

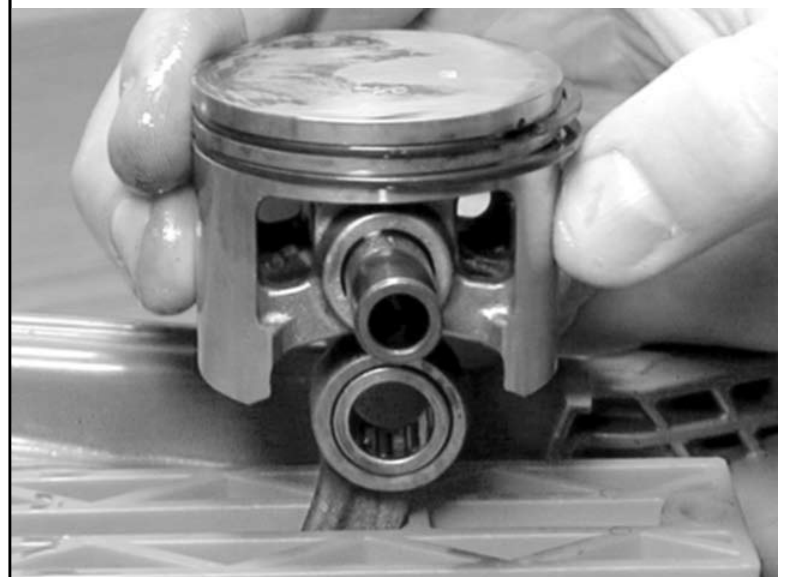

13.20 Install cylinder

- A Lubricate cylinder bore with ICS® 2-stroke oil.
- B Compress rings with ring compression tool.
- C Slide cylinder onto piston, pushing ring compression tool down.



13.21 Install cylinder.

- A Remove ring compression tool.
- B Slide cylinder down piston and into crankcase.
- C Align cylinder bolt holes with crankcase.

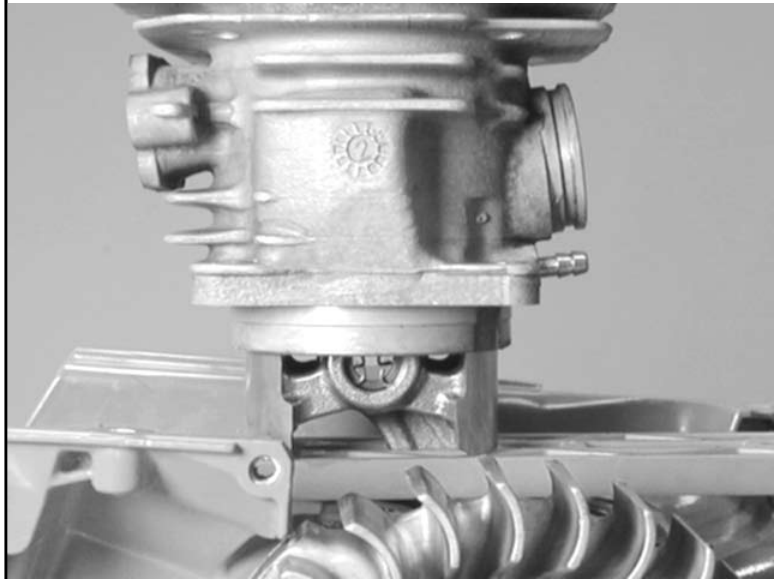

13.22 Install 4 cylinder screws and washers.

- A Use blue Loctite®.
- B Torque bolts to 95.5 in-lbs. (11 Nm)



13.23 Install rear manifold.

- A Lubricate rear manifold with ICS® 2-stroke oil.
- B Push rear manifold onto cylinder intake.
- C Align rear manifold seam with cylinder and crankcase seam.

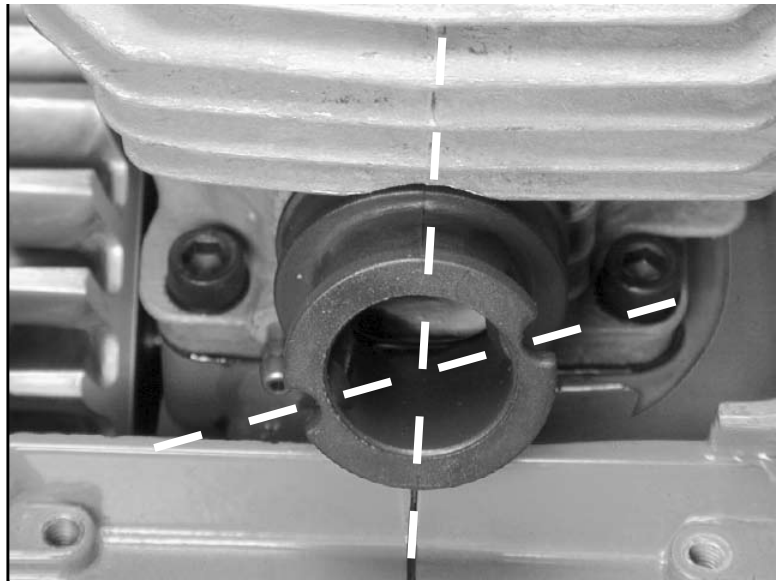

13.24 Install rear manifold clamp.

- A Torque to 11 in-lbs. (1 Nm)

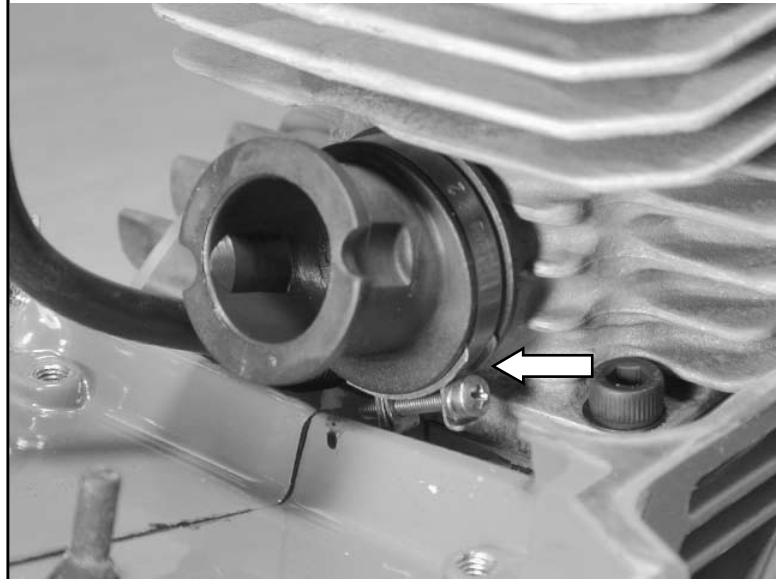

13.25 Install protective spring onto pulse tube.

13.26 Install the pulse tube onto cylinder barb.

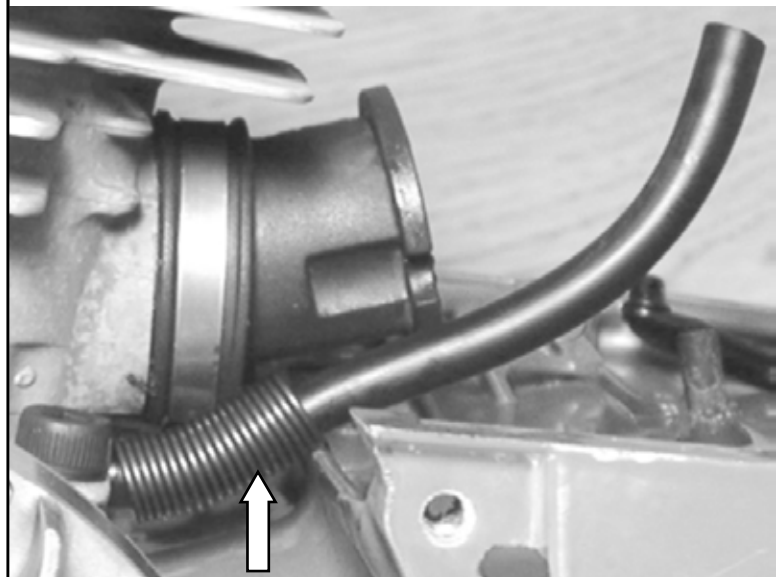

13.27 Install carburetor base.

- A Slip pulse tube into carburetor base.
- B Slip rear manifold into carburetor base.
- C Make sure rear manifold lip is flat.



13.28 Install carburetor base screws.

- A Use blue Loctite® on 3 screws without ground wire.
- B Make sure to include stop switch wire.
- C Torque to 35 in-lbs. (4 Nm).

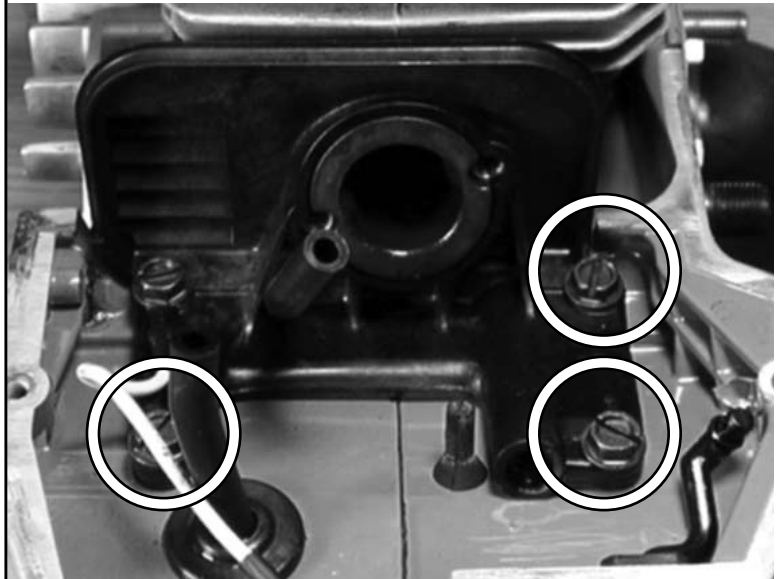

14 This section covers water hose and water tank cap.

- 14.1 Loosen hose clamp screw.
- 14.2 Remove water connection from hose.
- 14.3 Remove hose from hose hanger.



14.4 Remove water hose connector.



14.5 Unscrew water tank cap from saw.

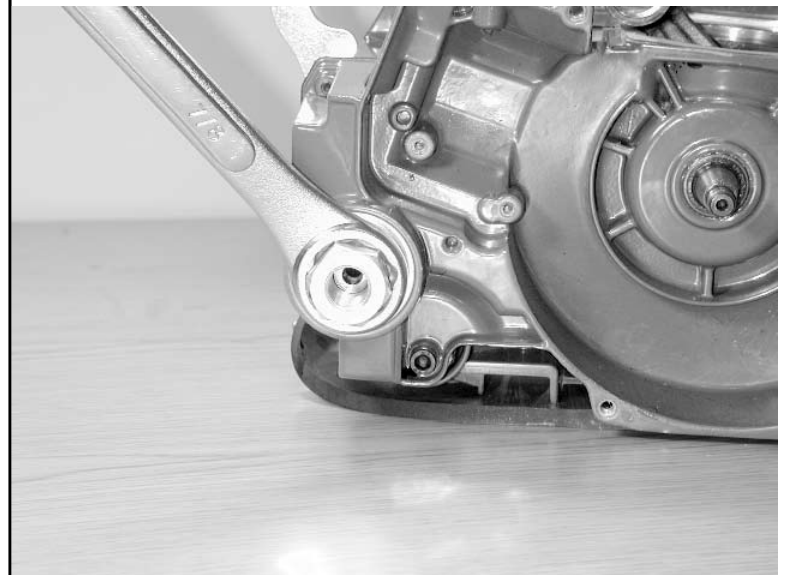

- 14.6 Release water tank cap from water tank tube.
- A Depress orange fitting as shown.
- 14.7 Assemble in the reverse order.

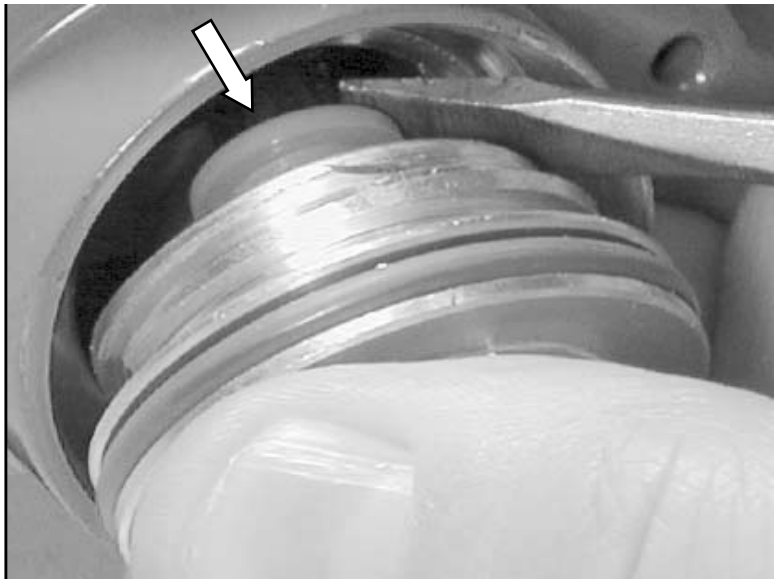

15 This section covers the removal, inspection, and installation of the ignition coil. Removal of the starter is required. Refer to section 8 if necessary.

15.1 Remove starter flywheel shroud by unhooking wires.

15.2 Remove ignition coil screws, wave washers and plain washers.

15.3 Remove ignition coil.

15.4 Inspect.

- A Look for cracks/missing insulation.
- B Clean flywheel magnets and coil if rusty.

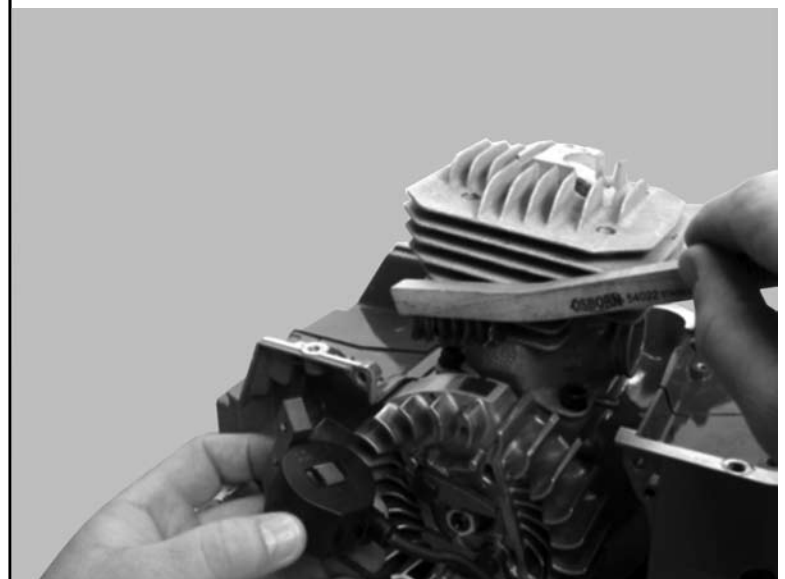

- 15.5 Install Ignition coil.
 - A Place ignition coil shim (0.012") on magnet counterweight side of flywheel.
 - B Set ignition coil in place.
 - C Install ignition coil screws, wave washers, and plain washers with blue Loctite®.
Holding shim, rotate flywheel magnet around to coil.
 - E Torque ignition coil screws to 26 in-lbs. (3 Nm).
 - F Remove shim, rotate flywheel to check clearance.
- 15.6 Install flywheel shroud
- 15.7 Route yellow ignition stop switch wire through crankcase into carburetor chamber.

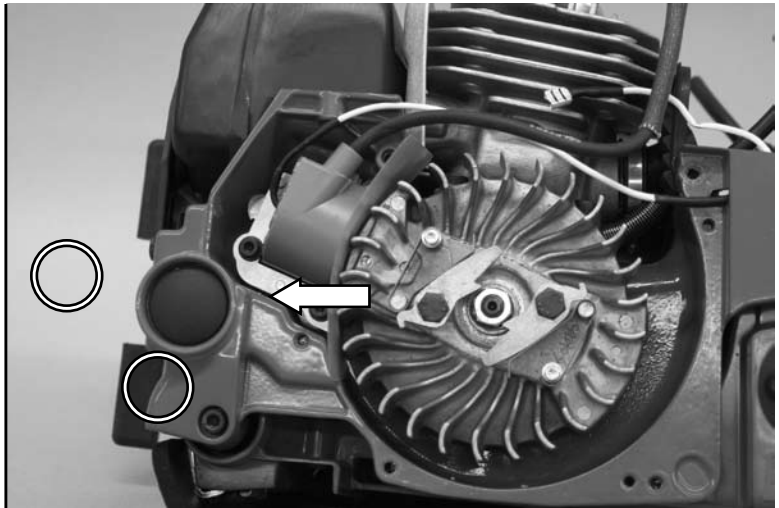

- 15.8 Complete ignition wire routing.



- 16** This section covers the removal, inspection, and installation of the flywheel. Removal of the starter and spark plug is required. Refer to sections 6 and 8 if necessary.

- 16.1 Insert piston stop.
16.2 Remove flywheel nut, wave washer, and plain washer.

- 16.3 Screw on flywheel removal tool finger tight. Unscrew tool 1 ½ turns leaving approximately 1/8 inch (5 mm) space between tool and flywheel.

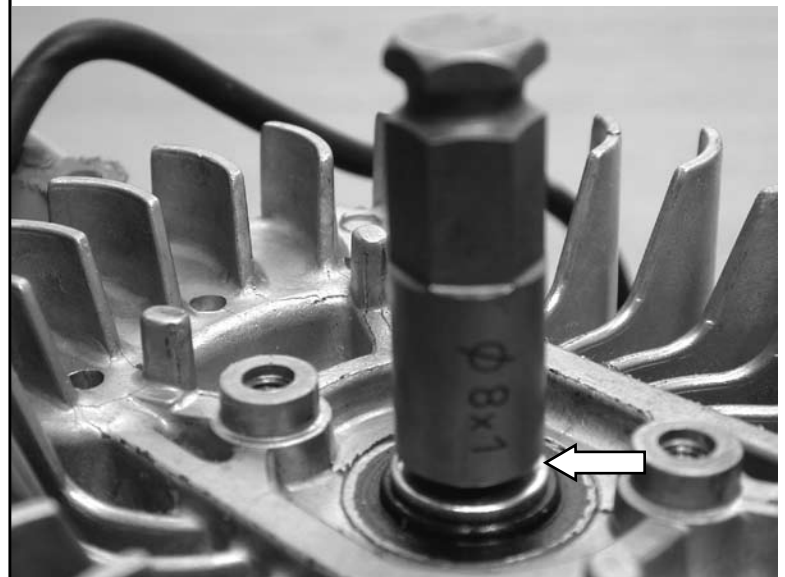

- 16.4 Using pliers, hold saw up by magnet counterweight.
- 16.5 Strike flywheel removal tool with a ball peen hammer. The flywheel should release from crankshaft.
- 16.6 Inspect and clean flywheel. Replace if any of the fins are broken.



- 16.7 Inspect woodruff key.



- 16.8 Install flywheel, plain washer, wave washer, and flywheel nut.
 - A Torque nut to 217 in-lbs. (25 Nm).



- 17** This section covers the removal, inspection, and installation of the bottom guard.
- A Remove bottom guard screws and split washers.
 - B Inspect bottom guard.
 - C Replace if damaged.
 - D Assemble in reverse order

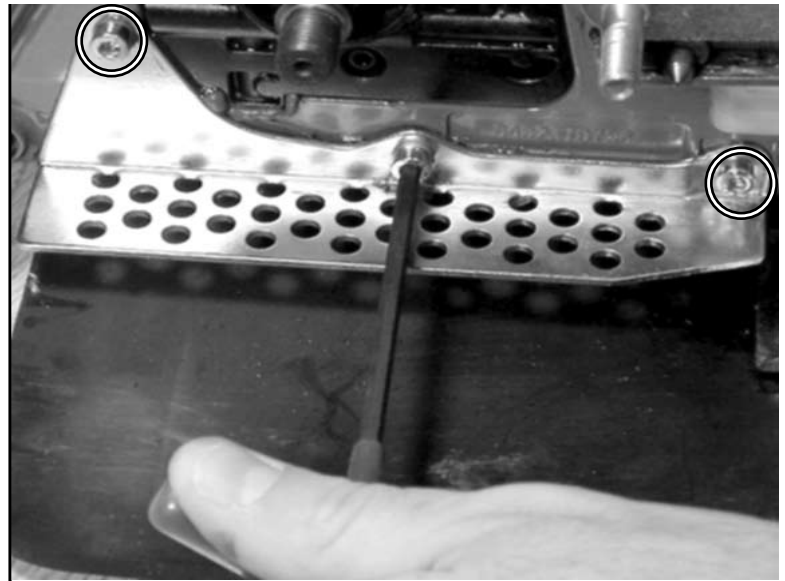

18 This section covers the removal, inspection, and installation of the front handle.

18.1 Remove front handle screws on right side.

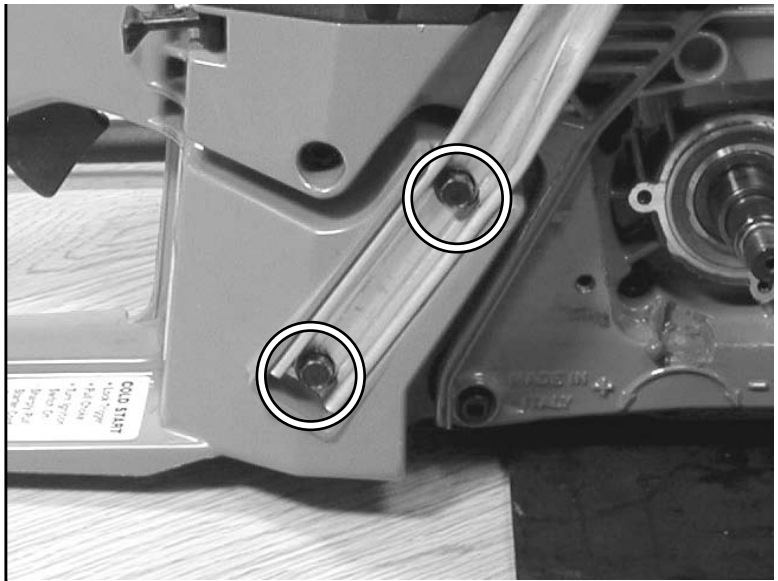

18.2 Remove front handle screws on bottom.

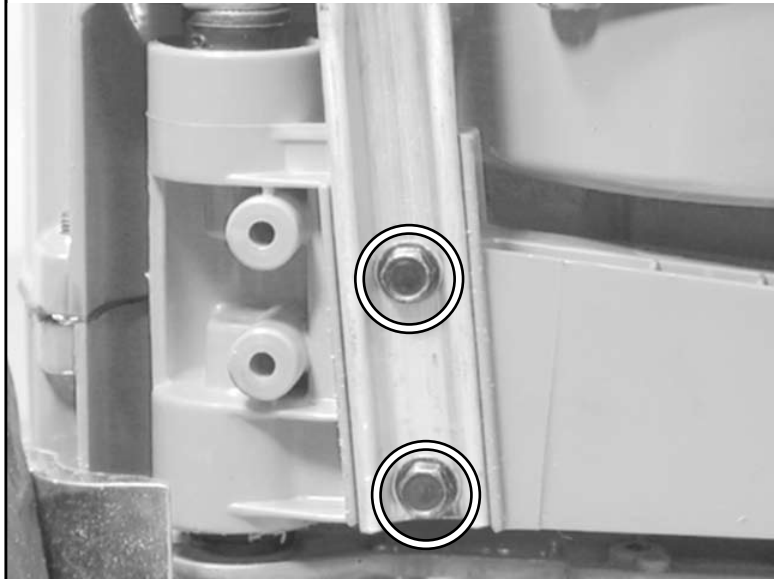

18.3 Install front handle.

- A Roll front handle into place.
- B Install front handle screws (4).
- C Use blue Loctite®.
- D Torque to 69 in-lbs. (8 Nm).



19 This section covers the disassembly, inspection, and assembly of the vibration isolators, fuel tank, and rear handle.

19.1 Remove vibration isolator screws and wave washers on clutch side of saw.

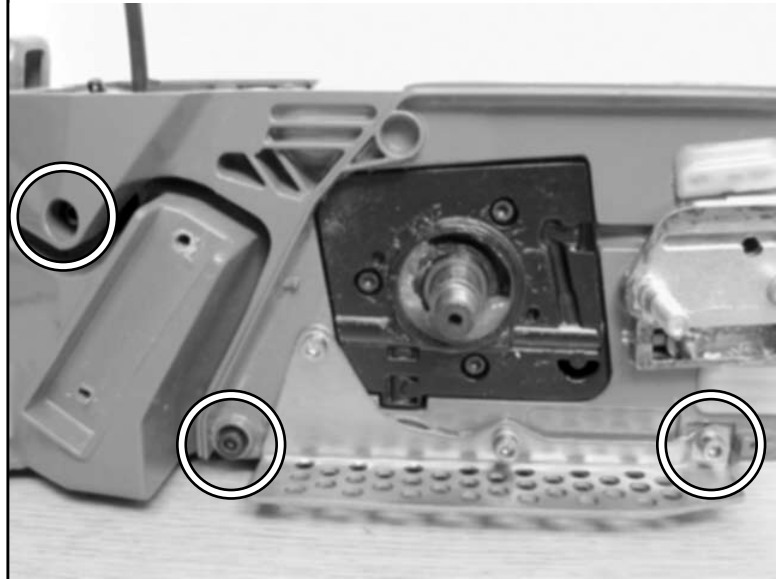

19.2 Remove vibration isolator screws and wave washers on flywheel side of saw.

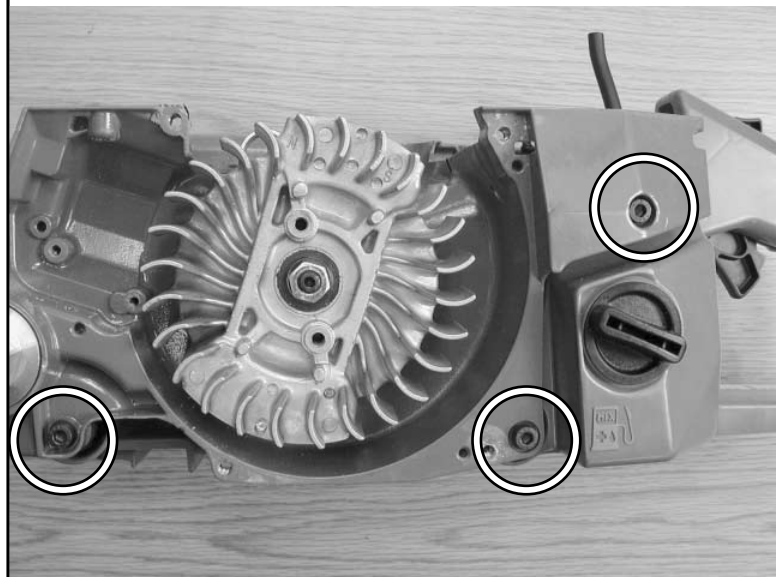

19.3 Separate crankcase and fuel tank.

NOTE: Saws have a rubber water deflector connected to the 2 bottom vibration isolators on the clutch side (circled).

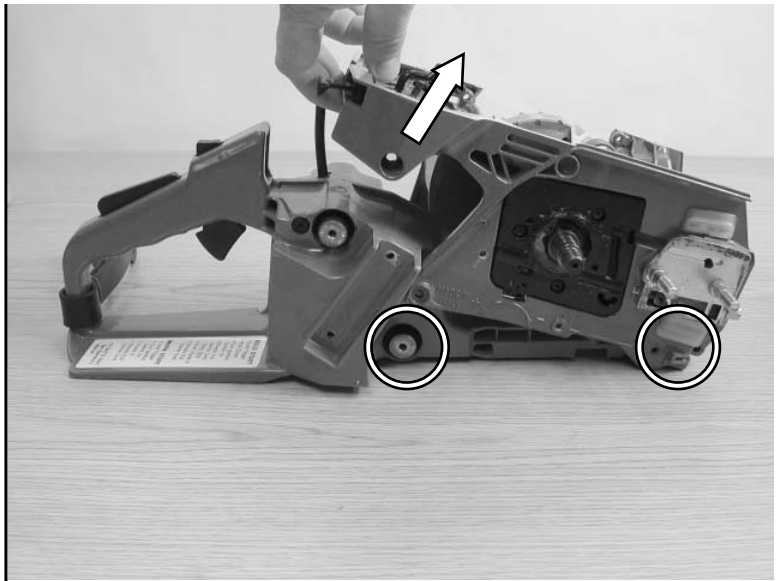

19.4 Remove vibration isolators from fuel tank (6) if necessary.



19.5 Assemble in reverse order.

NOTE: During assembly be careful to avoid kinking the fuel line.

20 This section covers the disassembly, inspection, and assembly of the crankcase seals and crankshaft bearings.

20.1 Remove outer crankshaft seal housing screws and wave washers.

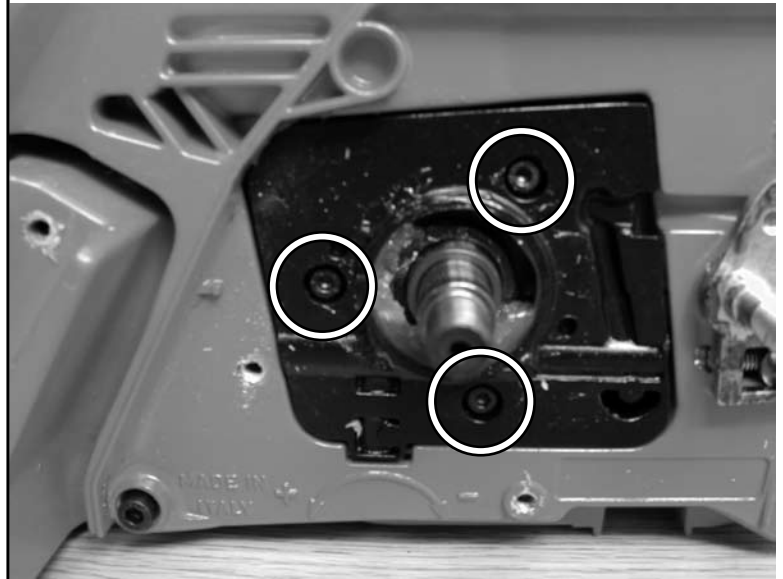

20.2 Remove crankcase bolts.

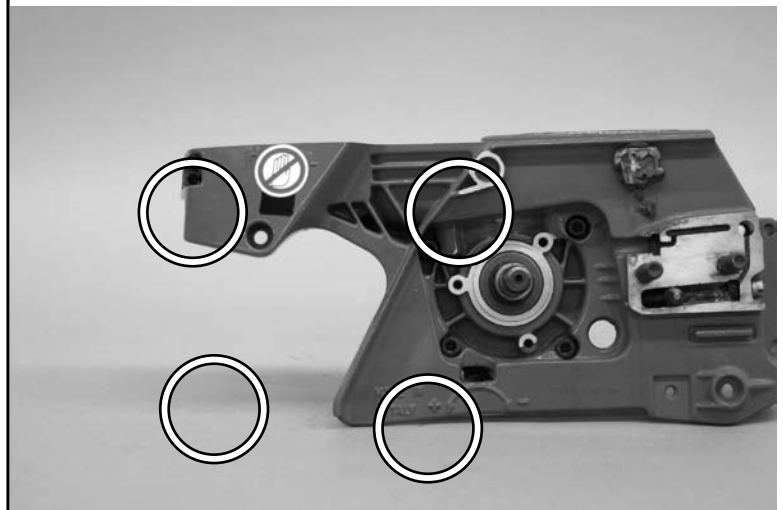

- 20.3 Heat the flywheel side crankcase with heat gun for 5 minutes, approximately 150° F (65.5° C).



- 20.4 Remove the flywheel side crankcase – tap crankshaft with plastic mallet.
- A Suspend above work surface.
 - B Tap with mallet.

NOTE: A nut should always be placed on a threaded shaft when pounding or pressing on it.



- 20.5 Remove the flywheel side crankcase seal with 1/2" (13 mm) socket.

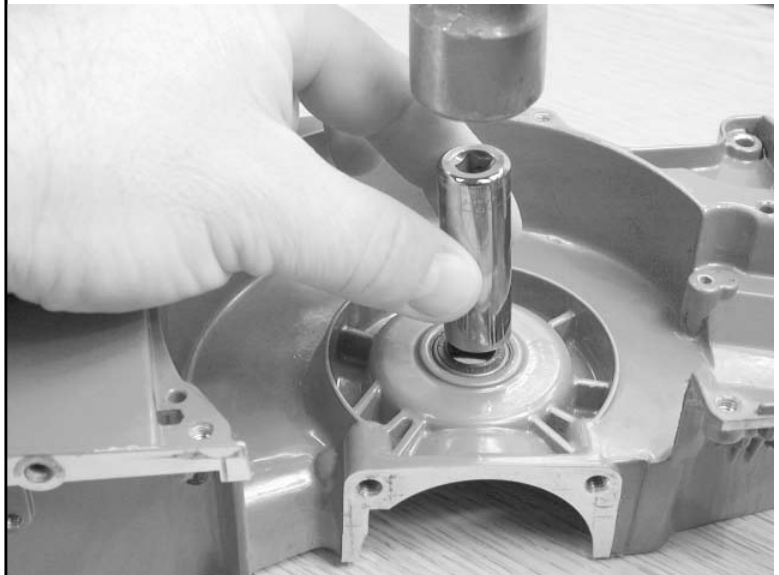

- 20.6 Heat the clutch side crankcase with heat gun to 150° F (65.5° C).

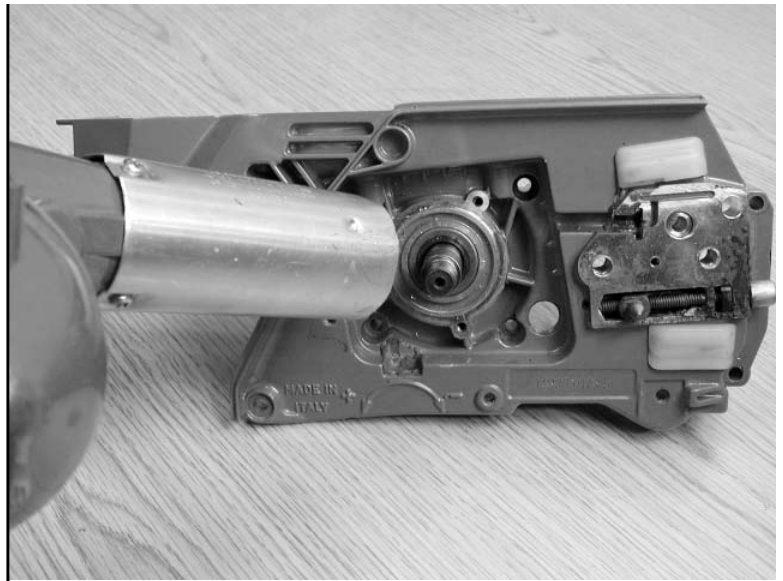

- 20.7 Remove crankshaft from the clutch-side crankcase tap crankshaft with a plastic mallet.
- A Suspend above work surface.
 - B Tap with plastic mallet.



- 20.8 Remove the bearing from the flywheel side of crankshaft.



- 20.9 Remove the bearing, seal, and bushing from the clutch side of crankshaft.



- 20.10 Clean mating crankcase faces.
20.11 Heat crankcase halves to 150° F.



- 20.12 Install bearing into crankcase halves.
20.13 Tap with bearing driver and mallet.

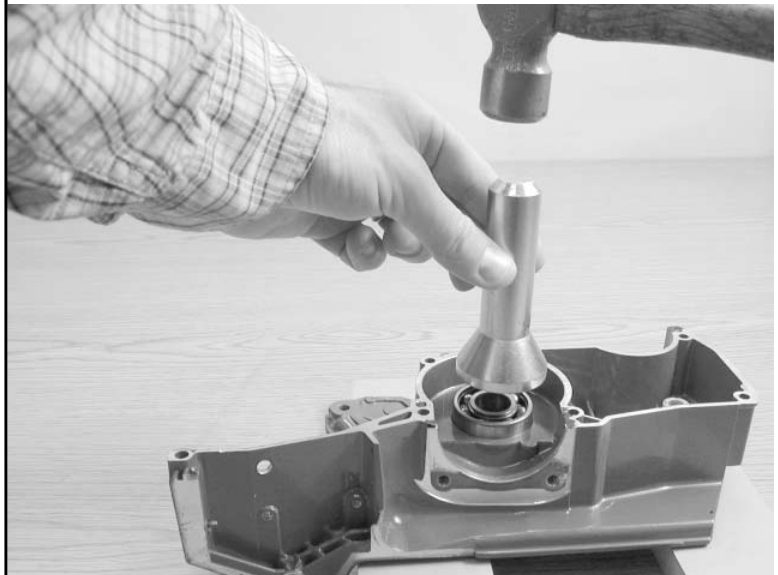

20.14 Repeat with other half.



20.15 Install crankshaft into clutch side of case.

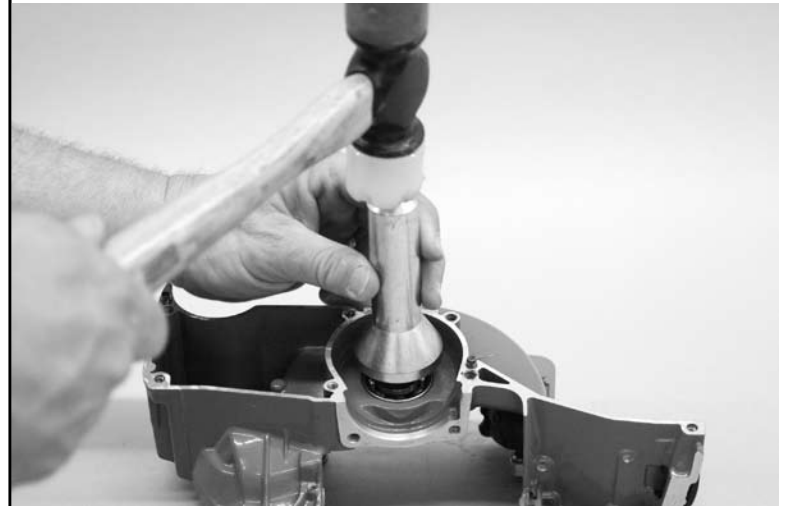

20.16 Place clutch side crank case seal on crankshaft.

- A Tap lightly with bearing driver and mallet.



20.17 Coat crankcase gasket with ICS®
2-stroke engine oil.

20.18 Align crankcase gasket on flywheel
side crankcase pins.

20.19 Place crankcase halves together and
align crankcase pins.

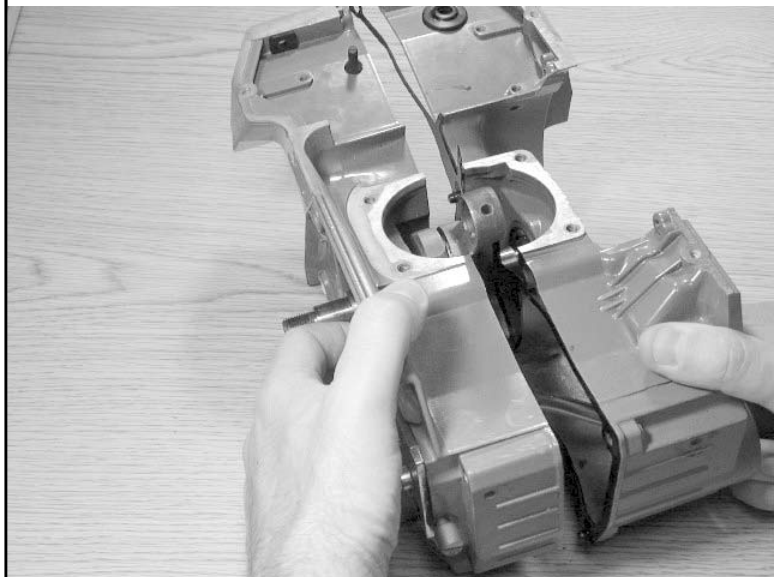
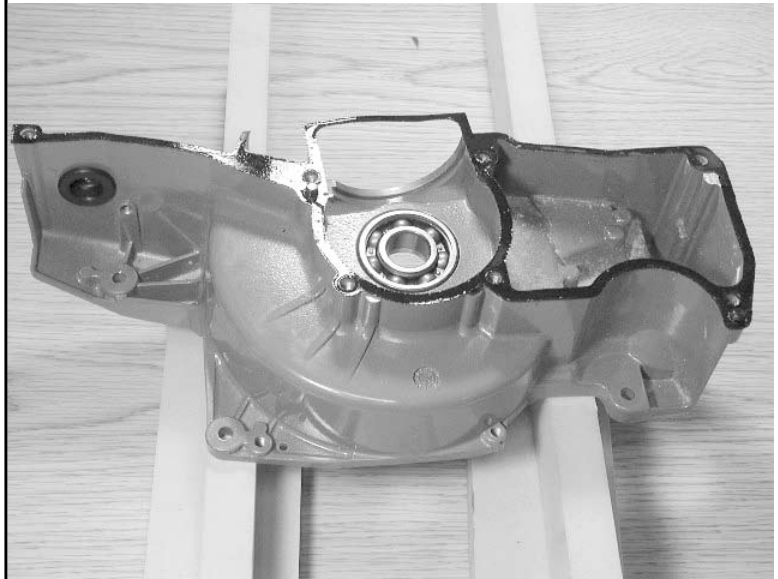

20.20 Assemble crankcase halves – tap with bearing driver and mallet.



20.21 Install main crankcase bolts.

A Use blue Loctite®.

B Torque to 69 in-lbs. (8 Nm).

NOTE: The 3 remaining crankcase bolts will be installed during the completion of the saw assembly.

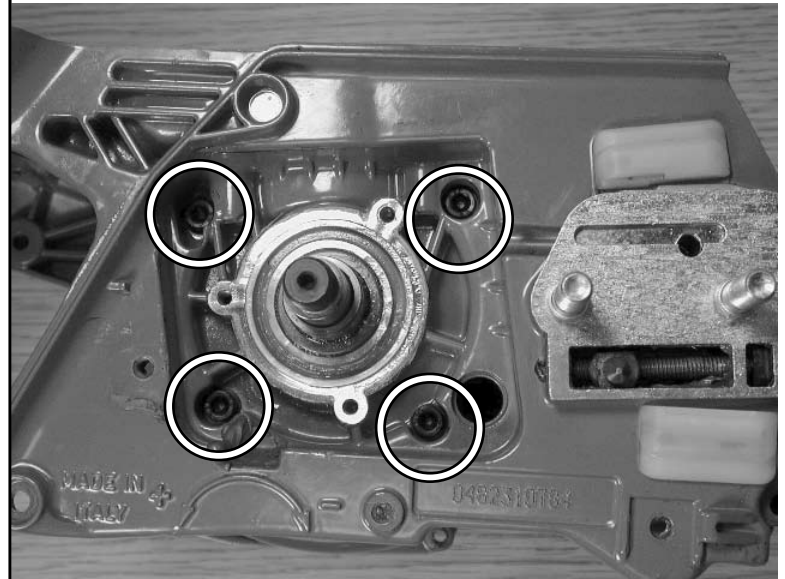

20.22 Install flywheel side crankcase seal – tap with bearing driver and mallet.

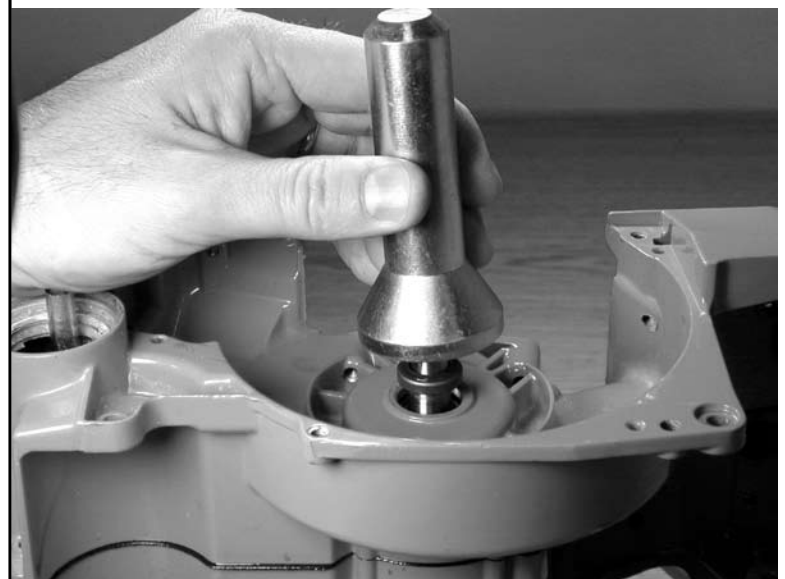

20.23 Trim crankcase gasket flush.



- 21** This section covers the removal and installation of the bar studs and bar pad.

NOTE: On saws with Serial #'s beginning 0482421700 and 071XXXXXXX, it is necessary to remove the bar mount pad cover plate first.

- 21.1 Remove bar studs.
- A Remove side cover.
 - B Install side cover nuts, flange to flange and tighten together.
 - C Attempt to remove the inside nut which should pull out the bar stud.
 - D Repeat on second bar stud.
- 21.2 Remove bar pad.
- A Remove sealing o-ring.
- 21.3 Assemble in reverse order.

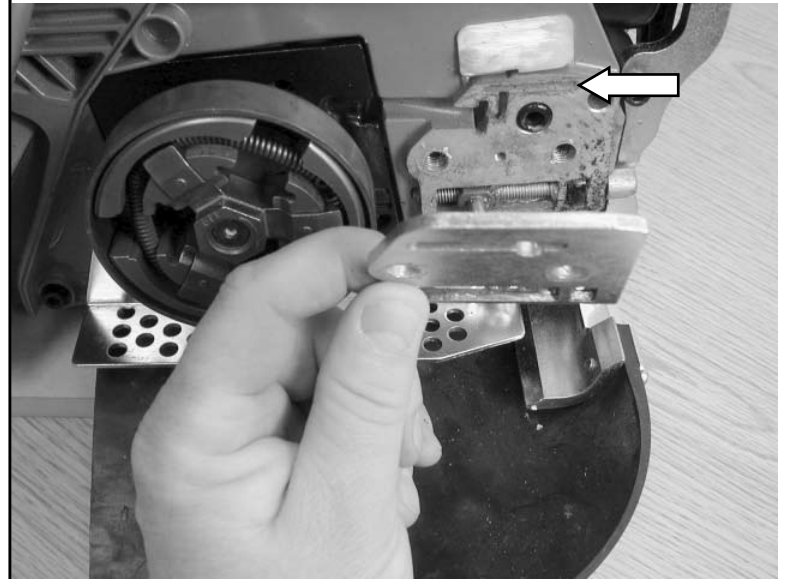
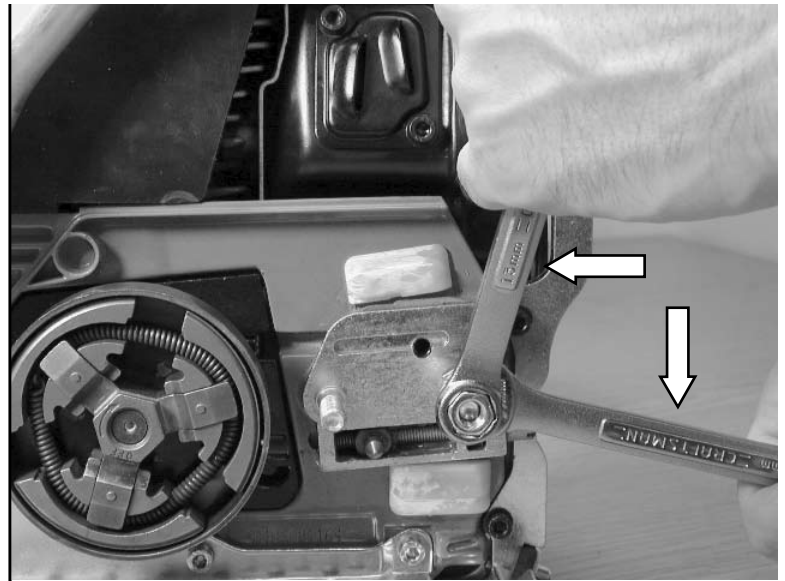

22 This section covers the removal and installation of the chain tensioner.

22.1 Remove bar plate to expose the chain tensioner.

NOTE: Saws with serial #'s lower than 0482421700 are not equipped with a bar mount pad cover plate.

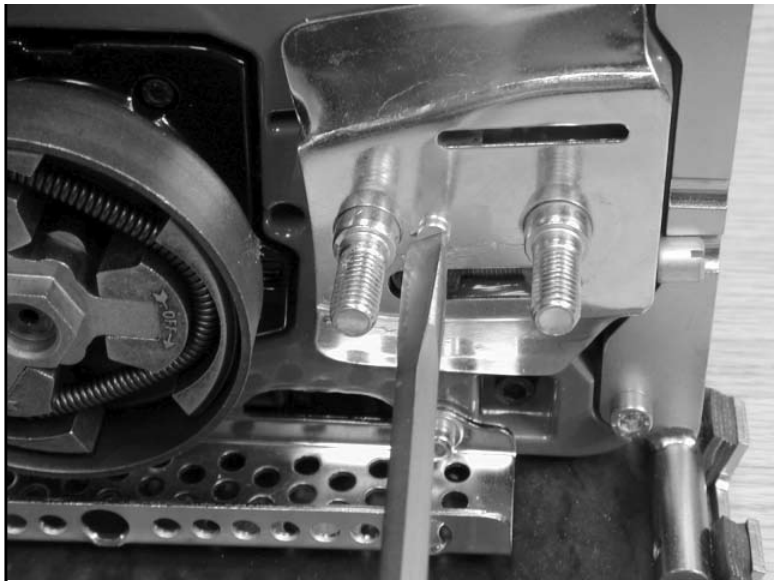

22.2 Unscrew tensioner to remove.

- A Remove tensioner pin.
- B Remove tensioner screw keeper.

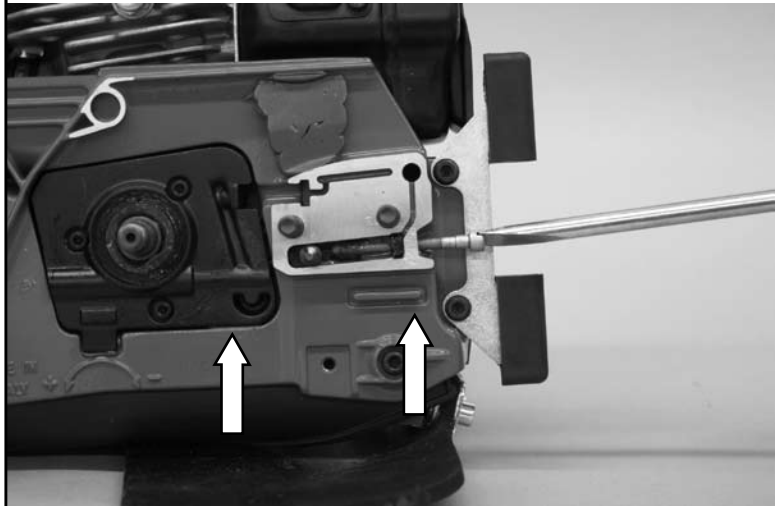

22.3 Assemble in reverse order.



- 23** This section covers carburetor tuning. Included in this section are basic settings, idle speed adjustment, and complete adjustment.

The carburetor has been set at the factory for optimal performance and compliance to EPA Phase I emissions standards. However, minor adjustments may be required in certain conditions, such as high elevation.

NOTES:

- These cut-off saws are equipped with an electronic speed limiter, as part of the ignition system. This will prevent the saw from going above 12,500 rpm. Attempting to set the carburetor mixture to increase the speed or power beyond this limit may seriously damage the engine.
- Always check the air filter, pre filter, fuel filter, and spark plug before making carburetor tunings and clean or replace if necessary

23.1 Basic Setting -

H = 1 3/4 turns from closed

L = 1 1/4 turns from closed

Complete carburetor readjustment.

23.2 Remove limiter cap

- A Look into adjustment screw hole. Observe orientation of the release slots on the adjustment screw limiter cap.
- B Insert the limiter cap puller blades into the release slots.
- C Firmly hold the tool shaft while screwing in the puller until the screw head is against the puller shaft.
- D Unscrew the puller screw.

RPM Settings for saws.

NOTE: Saw tuned without bar and chain installed.

Idle Speed = 3,000 ± 500 rpm

Full Throttle = 11,000 ± 500 rpm

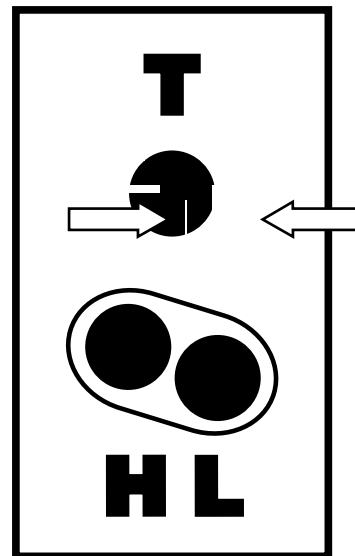

- 23.3 Using a 5/64" straight blade screwdriver, gently turn the adjustment screws clockwise until completely closed.
- 23.4 Set the adjustment screws at the Basic Setting:
 H = 1 3/4 turns from closed
 L = 1 1/4 turns from closed
- ⚠** The side cover must be held tightly in place with the side cover nuts, using a bar and no chain. Failure to do so may result in personal injury.
- 23.5 Start the saw and warm up the engine.
- 23.6 With a tachometer check the saw rpm, with no bar and chain:
- A Idle = 3,000 ± 300 rpm
 - B If the idle rpm does not fall into this rang, adjust the T screw, clockwise to raise RPM, counterclockwise to lower RPM.
- 23.7 With a tachometer check the saw full throttle rpm, with no bar and chain:
- A Target = 11,000 ± 500 rpm
- 23.8 If the full throttle rpm falls below this range, turn the H screw in (clockwise) 1/16th of a turn at a time.
- A Pulse the throttle to help stabilize the system.
- ⚠** Do not hold the saw at max rpm for more than 5 seconds or cylinder damage could occur.



23.9 When the carburetor is adjusted correctly set the limiter caps as shown with a 1/4" straight blade screwdriver.

- A L = vertical
- B H = horizontal

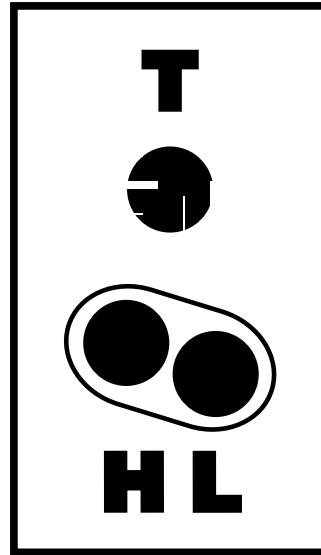

24 This section covers idle speed adjustment.

24.1 If engine stops while idling:

- A Make sure the chain is properly tensioned.
- B Turn T screw clockwise until chain begins to move
- C Back T screw out $\frac{1}{2}$ turn.

24.2 If chain turns at idle:

- A Back T screw out until chain stops moving.

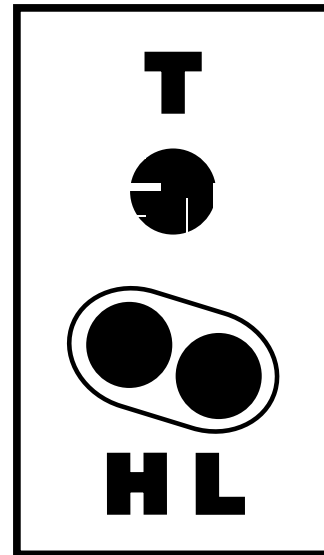

25 This section provides several flowcharts to aid diagnosing common problems.

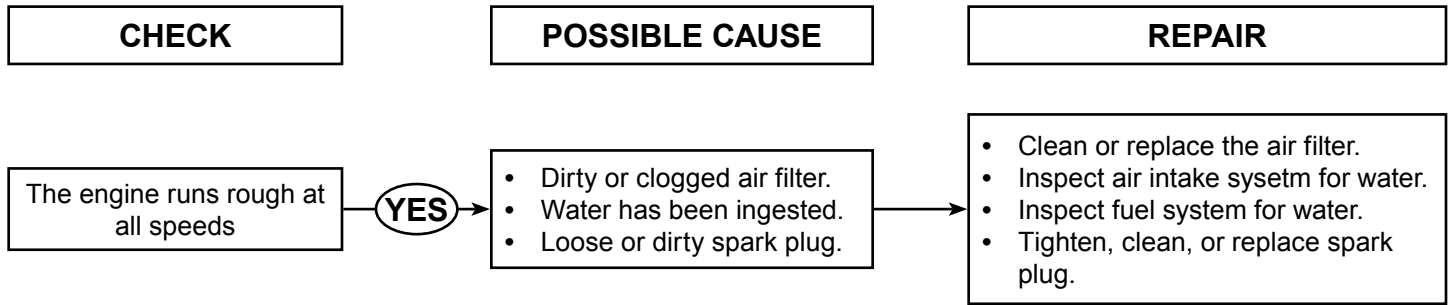

⚠ A dirty air filter is the #1 reason for engine problems.

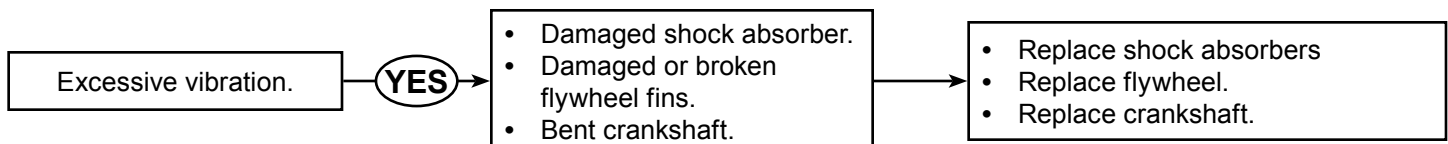
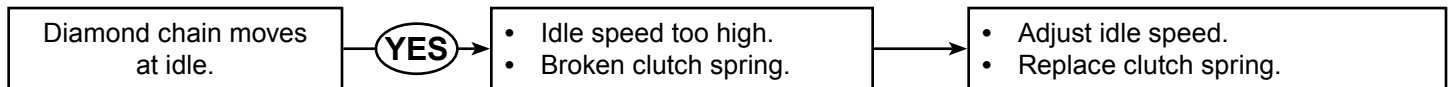
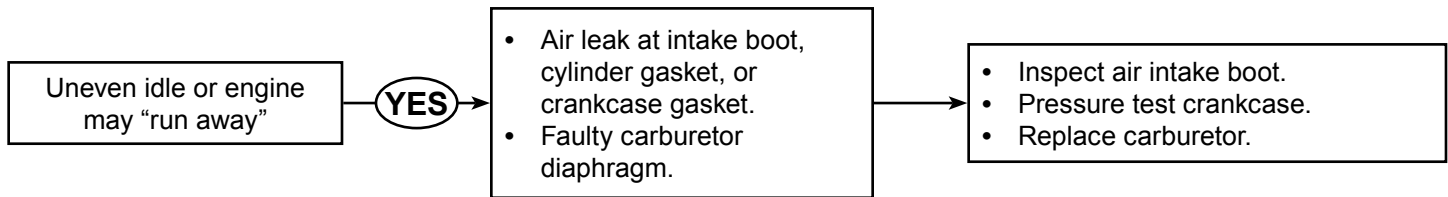
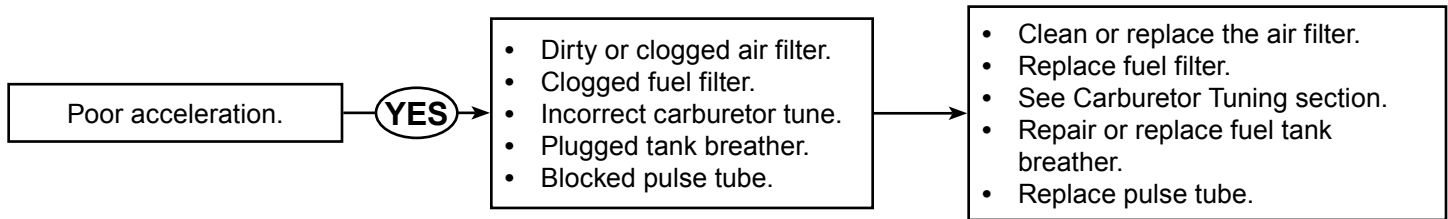
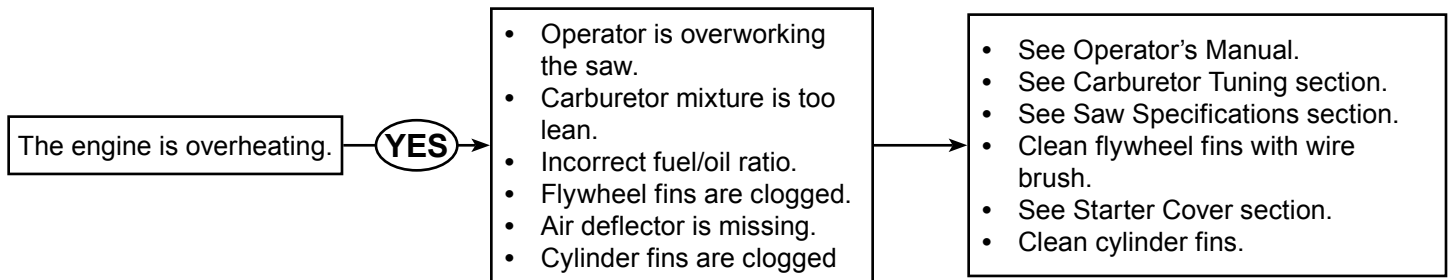

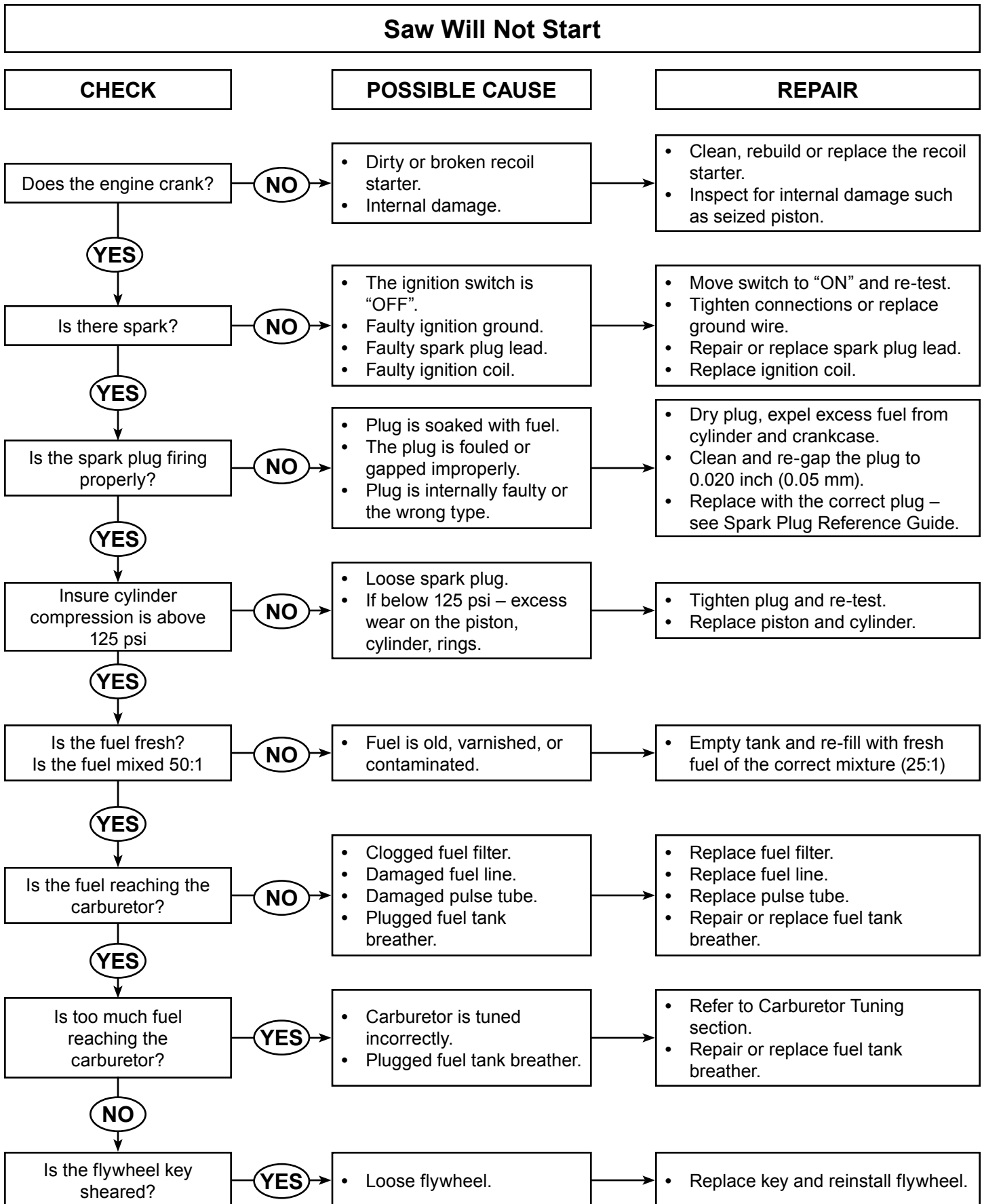

- 26** This section covers testing the fuel system for leaks. Engine starvation can result from a leak or malfunction of any of the main components of the fuel system. The five main components are the fuel tank, fuel tank breather, fuel filter, delivery tubes, and carburetor.

- 26.1** Remove and inspect the fuel filter.
- A** Replace the fuel filter if there is any foreign material in the felt or the internal screen.



- 26.2** Test the main fuel pick-up tube for leaks.
- A** Install the pressure gauge and bulb.
- B** Pressurize the tube to 7 psi (0.5 bar).
- C** If the pressure does not maintain, separate the fuel line from the carburetor.

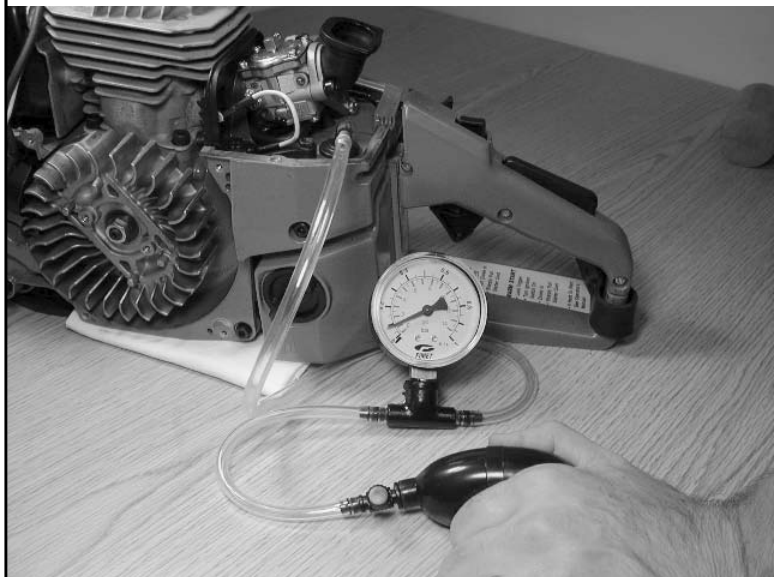

- D Plug one end of the main fuel pick-up tube.
- E Re-pressurize the tube to 7 psi (0.5 bar).
- F Replace the tube if pressure is not maintained.
- G If the main fuel pick-up tube does maintain pressure, then the leak has been isolated to the carburetor. Refer to the Walbro Diaphragm Carburetor Service Manual.

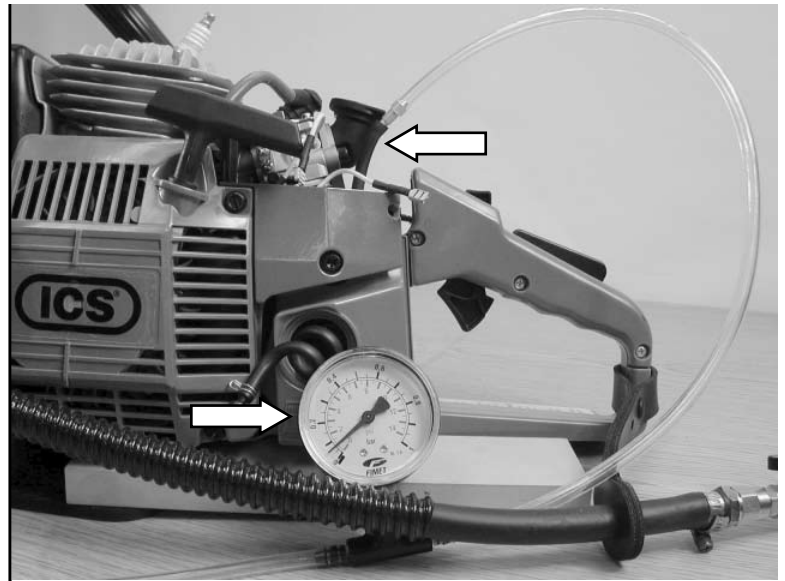

- 26.3 The fuel tank breather stabilizes the pressure in the fuel tank preventing both excessive pressure, which could flood the engine, and negative pressure, which could starve the engine of fuel.

- 26.4 Fuel tank breather is located inside the air filter compartment.



26.5 Testing the fuel tank breather.

- A Attach the pressure gauge and bulb to the main fuel pick-up tube at the carburetor. Pressurize the tube to 4.5 psi (0.3 bar).
- B The pressure should reduce to nearly 0 psi (0 bar) over about 3 seconds.

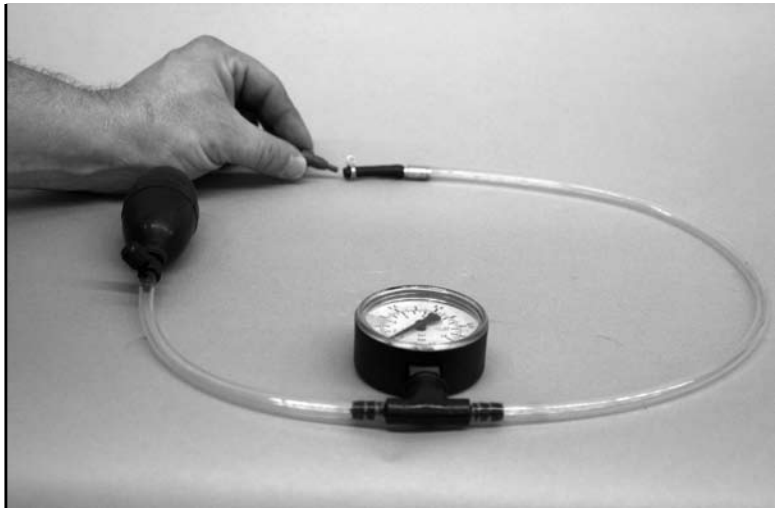

26.6 If the pressure does not reduce to 0 psi, disassemble or replace the breather.

- A Clean the parts with solvent or fuel.
- B Assemble in reverse order.
- C Make sure that the spring taper is oriented in the correct direction.

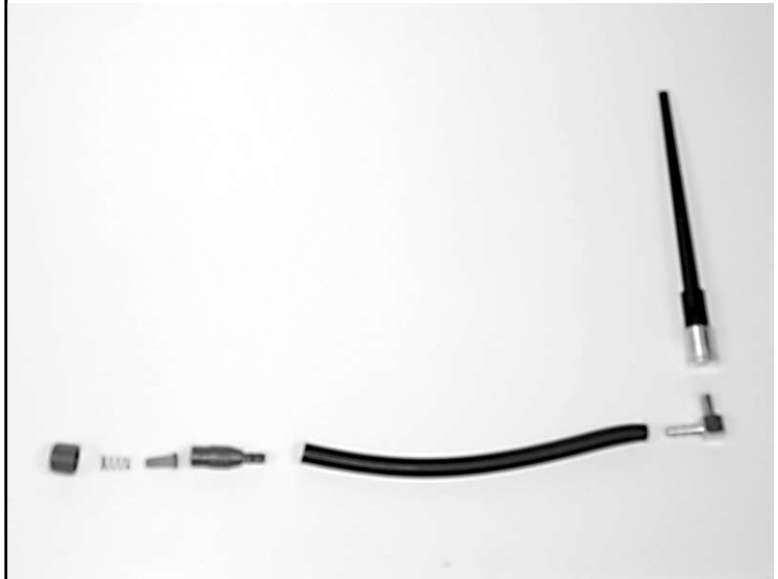

27 This section covers testing the crankcase for leaks. A leak in the crankcase can cause the engine not to run.

27.1 Install the intake seal flange.

A Plug cylinder pulse tube.

27.2 Install the exhaust seal flange.

27.3 Block one of the flange tubes with a rubber plug.

27.4 Install the pressure gauge and bulb.

27.5 Pressurize the crankcase to 7 psi (0.5 bar).

27.6 If the pressure does not remain the same, use soapy water to find the leak.

NOTE: It is recommended that this test be performed after an engine rebuild

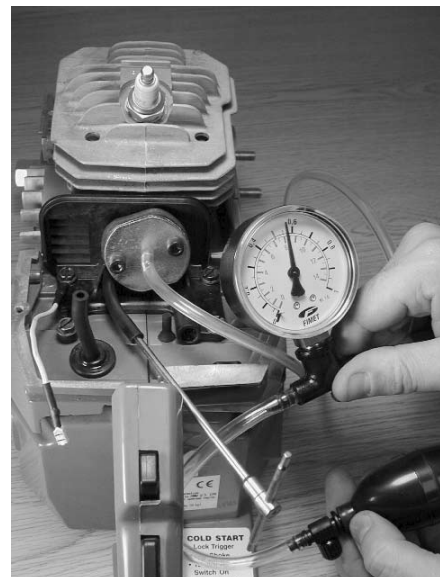
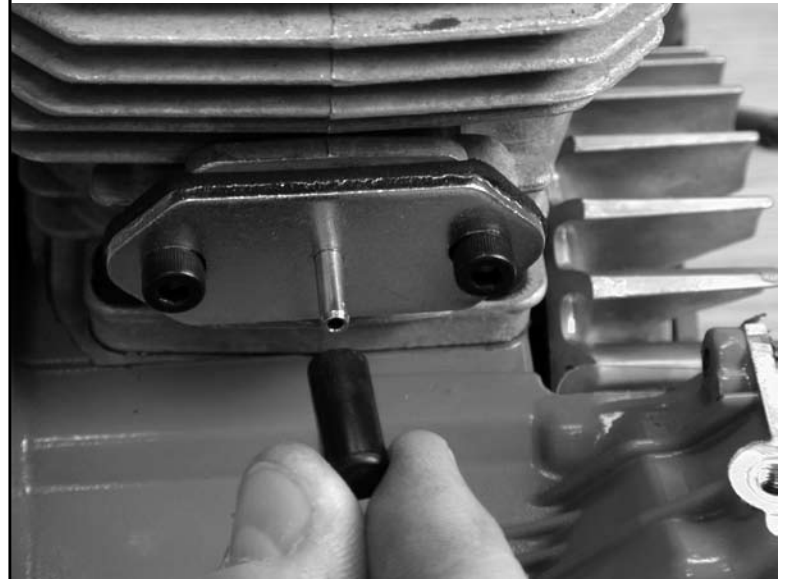
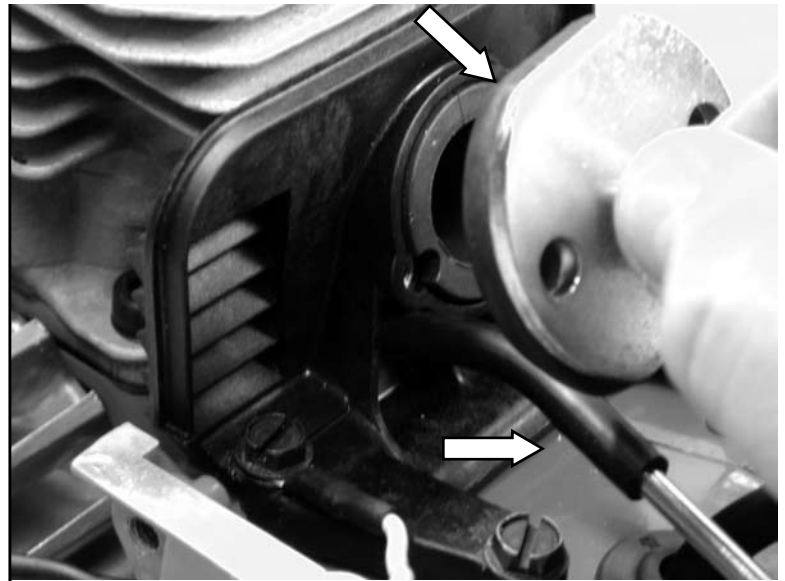

- 1 The Spark Plug Reference Guide is to be used as a guide only. When trying a plug from a different manufacturer, perform a plug check to be sure that the plug will work.

SPARK PLUG REFERENCE GUIDE

ICS RESISTOR	CHAMPION RESISTOR	NGK RESISTOR	BOSCH RESISTOR
73199	RCJ7Y	BPMR7A	WSR7F

613GC SERVICE MANUAL

ICS, Blount Inc.
4909 SE International Way
Portland, OR 97222
Tel 800-321-1240 Fax 503-653-4393
icsbestway.com